

Generalized feedback vertex set problems on bounded-treewidth graphs: chordality is the key to single-exponential parameterized algorithms*

Édouard Bonnet¹, Nick Brettell², O-joung Kwon³, and Dániel Marx¹

- 1 Institute for Computer Science and Control, Hungarian Academy of Sciences, (MTA SZTAKI)
- 2 School of Mathematics and Statistics, Victoria University of Wellington, New Zealand
- 3 Institute of Software Technology and Theoretical Computer Science, Technische Universität Berlin, Germany

Abstract

It has long been known that FEEDBACK VERTEX SET can be solved in time $2^{\mathcal{O}(w \log w)} n^{\mathcal{O}(1)}$ on graphs of treewidth w , but it was only recently that this running time was improved to $2^{\mathcal{O}(w)} n^{\mathcal{O}(1)}$, that is, to single-exponential parameterized by treewidth. We investigate which generalizations of FEEDBACK VERTEX SET can be solved in a similar running time. Formally, for a class of graphs \mathcal{P} , the BOUNDED \mathcal{P} -BLOCK VERTEX DELETION problem asks, given a graph G on n vertices and positive integers k and d , whether there is a set S of at most k vertices of G such that each block of $G - S$ has at most d vertices and is in \mathcal{P} . Assuming that \mathcal{P} is recognizable in polynomial time and satisfies a certain natural hereditary condition, we give a sharp characterization of when single-exponential parameterized algorithms are possible for fixed values of d :

- if \mathcal{P} consists only of chordal graphs, then the problem can be solved in time $2^{\mathcal{O}(wd^2)} n^{\mathcal{O}(1)}$,
- if \mathcal{P} contains a graph with an induced cycle of length $\ell \geq 4$, then the problem is not solvable in time $2^{\mathcal{O}(w \log w)} n^{\mathcal{O}(1)}$ even for fixed $d = \ell$, unless the ETH fails.

As a warm up, we consider the analogous BOUNDED \mathcal{P} -COMPONENT VERTEX DELETION problem requiring each connected component to be a member of \mathcal{P} , and show that chordality is also the key to single-exponential parameterized algorithms for this problem.

1998 ACM Subject Classification G.2.1 Combinatorial Algorithms – G.2.2 Graph Algorithms

Keywords and phrases chordal graphs, fixed-parameter tractable algorithms, treewidth, feedback vertex set, component order connectivity

Digital Object Identifier 10.4230/LIPIcs...

1 Introduction

Treewidth is a measure of how well a graph accommodates a decomposition into a tree-like structure. In the field of parameterized complexity, many NP-hard problems have been

* All authors were supported by ERC Starting Grant PARAMTIGHT (No. 280152). The third author was also supported by the European Research Council (ERC) under the European Union's Horizon 2020 research and innovation programme (ERC consolidator grant DISTRUCT, agreement No. 648527).



shown to have FPT algorithms when parameterized by treewidth; for example, COLORING, VERTEX COVER, FEEDBACK VERTEX SET, and STEINER TREE (see [5, Section 7] for further examples). In fact, Courcelle [4] established a meta-theorem that every problem definable in MSO_2 logic can be solved in linear time on graphs of bounded treewidth. While Courcelle's Theorem is a very general tool for obtaining algorithmic results, for specific problems dynamic programming techniques usually give algorithms where the running time $f(w)n^{\mathcal{O}(1)}$ has better dependence on treewidth w . There is some evidence that careful implementation of dynamic programming (plus maybe some additional ideas) gives optimal dependence for some problems (see, e.g., [11]).

For FEEDBACK VERTEX SET, standard dynamic programming techniques give $2^{\mathcal{O}(w \log w)} n^{\mathcal{O}(1)}$ -time algorithms and it was considered plausible that this is the best possible form of running time. Hence it was a remarkable surprise when it turned out that $2^{\mathcal{O}(w)} n^{\mathcal{O}(1)}$ algorithms are also possible for this problem by various techniques: Cygan et al. [6] obtained a $3^w n^{\mathcal{O}(1)}$ -time randomized algorithm by using the so-called Cut & Count technique, and Bodlaender et al. [1] showed there is a deterministic $2^{\mathcal{O}(w)} n^{\mathcal{O}(1)}$ -time algorithm by using a rank-based approach and the concept of representative sets. This was also later shown in the more general setting of representative sets in matroids by Fomin et al. [10].

Generalized feedback vertex set problems. In this paper, we explore the extent to which these results apply for generalizations of FEEDBACK VERTEX SET. The FEEDBACK VERTEX SET problem asks for a minimum set S of vertices such that $G - S$ is acyclic, or in other words, $G - S$ has only trivial blocks, that is, edges or vertices. We consider generalizations where we allow the blocks to be some other type of small graph, such as triangles, small cycles, or small cliques; these generalizations were first formally studied in [3]. The main result of this paper is that the existence of single-exponential algorithms is closely linked to whether the small graphs we are allowing are all chordal or not. Formally, we consider the following problem:

BOUNDED \mathcal{P} -BLOCK VERTEX DELETION

Parameter: d, w

Input: A graph G of treewidth at most w , and positive integers d and k .

Question: Is there a set $S \subseteq V(G)$ with $|S| \leq k$ such that each block of $G - S$ has at most d vertices and is in \mathcal{P} ?

The result of Bodlaender et al. [1] implies that when $d = 2$, BOUNDED \mathcal{P} -BLOCK VERTEX DELETION can be solved in time $2^{\mathcal{O}(w)} n^{\mathcal{O}(1)}$. Our main question is for which graph classes \mathcal{P} can these two problems be solved in time $2^{\mathcal{O}(w)} n^{\mathcal{O}(1)}$, when we regard d as a fixed constant. It turns out that chordal graphs have an important role in answering this question. A graph is *chordal* if it has no induced cycles of length at least 4. We show that if \mathcal{P} consists of only chordal graphs, then we can solve this problem in single-exponential time for fixed d .

► **Theorem 1.** *Let \mathcal{P} be a class of graphs that is block-hereditary, recognizable in polynomial time, and consists of only chordal graphs. Then BOUNDED \mathcal{P} -BLOCK VERTEX DELETION can be solved in time $2^{\mathcal{O}(wd^2)} k^2 n$ on graphs with n vertices and treewidth w .*

The condition that \mathcal{P} is block-hereditary ensures that the class of graphs containing blocks in \mathcal{P} is hereditary. A formal definition is given in Section 2. Theorem 1 implies that, for any fixed $d \geq 1$, the problem admits a $2^{\mathcal{O}(w)} n^{\mathcal{O}(1)}$ -time algorithm if \mathcal{P} satisfies the conditions. We complement this result by showing that if \mathcal{P} contains a graph that is not chordal, then single-exponential algorithms are not possible (assuming ETH), even for fixed values of d .

► **Theorem 2.** *For any fixed integer $d \geq 4$, if \mathcal{P} contains the cycle graph on $\ell \geq 4$ vertices, then BOUNDED \mathcal{P} -BLOCK VERTEX DELETION is not solvable in time $2^{\mathcal{O}(w \log w)} n^{\mathcal{O}(1)}$ on*

graphs of treewidth at most w even for fixed $d = \ell$, unless the ETH fails.

In particular, if \mathcal{P} is block-hereditary and contains a graph that is not chordal, then this graph contains a chordless cycle on $\ell \geq 4$ vertices and consequently the cycle graph on ℓ vertices is also in \mathcal{P} .

Bounded-size components. To better understand how chordality helps single-exponential time algorithms, we first consider a related but somewhat simpler problem, where we want to delete the minimum number of vertices such that each *connected component* has size at most d and belongs to \mathcal{P} .

BOUNDED \mathcal{P} -COMPONENT VERTEX DELETION	Parameter: d, w
Input: A graph G of treewidth at most w , and positive integers d and k .	
Question: Is there a set $S \subseteq V(G)$ with $ S \leq k$ such that each connected component of $G - S$ has at most d vertices and is in \mathcal{P} ?	

If we have only the size constraint (i.e., \mathcal{P} contains every graph), then this problem is known as COMPONENT ORDER CONNECTIVITY. Drange, Dregi, and van 't Hof [7] studied the parameterized complexity of a weighted variant of the COMPONENT ORDER CONNECTIVITY problem; their results imply, in particular, that COMPONENT ORDER CONNECTIVITY can be solved in time $2^{\mathcal{O}(k \log d)}n$, but is $W[1]$ -hard parameterized by only k or d . The corresponding edge-deletion problem, parameterized by treewidth, was studied by Enright and Meeks [8].

For general classes \mathcal{P} , we prove results that are analogous to what we obtained for BOUNDED \mathcal{P} -BLOCK VERTEX DELETION.

► **Theorem 3.** *Let \mathcal{P} be a class of graphs that is hereditary, recognizable in polynomial time, and consists of only chordal graphs. Then BOUNDED \mathcal{P} -COMPONENT VERTEX DELETION can be solved in time $2^{\mathcal{O}(wd^2)}k^2n$ on graphs with n vertices and treewidth w .*

► **Theorem 4.** *For any fixed integer $d \geq 4$, if \mathcal{P} contains the cycle graph on $\ell \geq 4$ vertices, then BOUNDED \mathcal{P} -COMPONENT VERTEX DELETION is not solvable in time $2^{\mathcal{O}(w \log w)}n^{\mathcal{O}(1)}$ on graphs of treewidth at most w even for fixed $d = \ell$, unless the ETH fails.*

When d is not fixed, one might ask whether BOUNDED \mathcal{P} -COMPONENT VERTEX DELETION admits an $f(w)n^{\mathcal{O}(1)}$ -time algorithm; that is, an FPT algorithm parameterized only by treewidth. We provide a negative answer, showing that the problem is $W[1]$ -hard when \mathcal{P} contains all chordal graphs, even parameterized by both treewidth and k . Note that this includes the COMPONENT ORDER CONNECTIVITY problem. We also prove two stronger lower bound results assuming the ETH holds.

► **Theorem 5.** *Let \mathcal{P} be a hereditary class containing all chordal graphs. Then BOUNDED \mathcal{P} -COMPONENT VERTEX DELETION is $W[1]$ -hard parameterized by the combined parameter (w, k) . Moreover, unless the ETH fails, this problem*

1. *has no $f(w)n^{\mathcal{O}(w)}$ -time algorithm; and*
2. *has no $f(k')n^{\mathcal{O}(k'/\log k')}$ -time algorithm, where $k' = w + k$.*

Techniques. A natural approach to tackle Theorem 3 is to consider target graphs as d -labeled graphs, where any two vertices in the same connected component have distinct labels in $\{1, \dots, d\}$. This allows us to store possible attachments of d -labeled graphs at each bag of a tree decomposition. However, if we simply store all possibilities, then each table assigned to a bag may have size $2^{\mathcal{O}(w \log w)}$. See Fig. 1 for an example. We show that when

\mathcal{P} consists of only chordal graphs, it is sufficient to keep some local information about the vertices in a bag and their neighbors, which can be used to determine whether they can be completed to a target chordal graph. Using this idea, we reduce the size of each table to $2^{\mathcal{O}(w)}$. It is essential for \mathcal{P} to consist of only chordal graphs for this approach to work, as shown by Theorem 2.

Two particular problems appear when we extend this approach to BOUNDED \mathcal{P} -BLOCK VERTEX DELETION. One problem is that a connected component in the target graph can be arbitrarily large. We still use a similar idea, but instead of treating each connected component as a d -labeled graph, we treat each block as a d -labeled graph. The other problem is that an unbounded number of blocks may intersect a vertex in a bag. We sidestep this issue by focusing on blocks that induce some connected component with at least two vertices in a bag.

The approach for BOUNDED \mathcal{P} -BLOCK VERTEX DELETION consists of two parts. For each block of size at least two in a bag, we store some local information, as for BOUNDED \mathcal{P} -COMPONENT VERTEX DELETION. This will be used to determine whether the blocks of the resulting graph that induce a connected component with at least two vertices in the bag are in \mathcal{P} and have at most d vertices. But this is not sufficient to determine whether the whole graph has this property, since there is a possibility of linking two controlled blocks by a sequence of uncontrolled blocks in both sides, and thus creating a chordless cycle. The remaining difficulty is handling partitions of the set of connected components induced by the bag; we do this using representative sets, in a similar manner to the single-exponential time algorithm for FEEDBACK VERTEX SET.

The paper is organized as follows. Section 2 introduces the necessary notions including labelings, treewidth, and boundaried graphs. In Section 3, we prove a structural lemma of labeled chordal graphs that is a key lemma for solving both problems. In Sections 4 and 5, we prove Theorems 3 and 1, respectively. Section 6 shows that if \mathcal{P} contains the cycle graph on d vertices, then both problems are not solvable in time $2^{o(w \log w)} n^{\mathcal{O}(1)}$ on graphs of treewidth at most w , unless the ETH fails. In Section 7, we further show that if d is not fixed and \mathcal{P} contains all chordal graphs, then BOUNDED \mathcal{P} -COMPONENT VERTEX DELETION is $W[1]$ -hard parameterized both k and w .

2 Preliminaries

Let G be a graph. We denote the vertex set and edge set of G by $V(G)$ and $E(G)$, respectively. We refer to the *size* of a subgraph H of G as the number of vertices in H . For a vertex v in G , the *deletion* of v in G is the graph obtained by removing v and its incident edges, and is denoted $G - v$. For $X \subseteq V(G)$, we denote by $G - X$ the deletion of every $x \in X$. For a vertex v in G , we denote by $N_G(v)$ the set of neighbors of v in G , and $N_G[v] := N_G(v) \cup \{v\}$. For $X \subseteq V(G)$, we let $N_G(X) := \bigcup_{v \in X} N_G(v) \setminus X$. For two graphs G_1 and G_2 , $G_1 \cup G_2$ is the graph with the vertex set $V(G_1) \cup V(G_2)$ and the edge set $E(G_1) \cup E(G_2)$, and $G_1 \cap G_2$ is the graph with the vertex set $V(G_1) \cap V(G_2)$ and the edge set $E(G_1) \cap E(G_2)$.

A vertex v of G is a *cut vertex* if the deletion of v from G increases the number of connected components. We say G is *biconnected* if it is connected and has no cut vertices. Note that every connected graph on at most two vertices is biconnected. A *block* of G is a maximal biconnected subgraph of G . We say G is *2-connected* if it is biconnected and $|V(G)| \geq 3$.

An induced cycle of length at least four is called a *chordless cycle*. A graph is *chordal* if it has no chordless cycles. For a class of graphs \mathcal{P} , a graph is called a *\mathcal{P} -component graph*

if each of its connected components is in \mathcal{P} , and a graph is called a \mathcal{P} -*block graph* if each of its blocks is in \mathcal{P} . A class of graphs \mathcal{C} is *hereditary* if for every $G \in \mathcal{C}$ and every induced subgraph H of G , $H \in \mathcal{C}$. A class \mathcal{C} of graphs is *block-hereditary* if for every $G \in \mathcal{C}$ and every biconnected induced subgraph H of G , $H \in \mathcal{C}$. Note that a block-hereditary class is not necessarily hereditary. For instance, if \mathcal{C} consists of K_1 , K_2 , and all induced cycles, then \mathcal{C} is block-hereditary but not hereditary, and \mathcal{C} -block graphs are the class of graphs known as cactus graphs.

For a positive integer d , we denote the set $\{1, \dots, d\}$ by $[d]$, and for two integers d_1, d_2 with $d_1 \leq d_2$, we let $[d_1, d_2]$ denote $\{d_1, d_1 + 1, \dots, d_2\}$. For a function $f : X \rightarrow Y$ and $X' \subseteq X$, the function $f' : X' \rightarrow Y$ where $f'(x) = f(x)$ for all $x \in X'$ is called the *restriction* of f on X' , and is denoted $f|_{X'}$. For such a pair of functions f and f' , we also say that f *extends* f' to the set X .

2.1 A d -labeling and a block d -labeling of a graph

A d -*labeling* of a graph G is a function L_G from $V(G)$ to $[d]$ such that for each connected component C of G , $L_G|_{V(C)}$ is an injection. If G is equipped with a d -labeling L_G , then G is called a d -*labeled graph*. We call $L_G(v)$ the *label* of v . A *block d -labeling* of a graph G is a function L_G from $V(G)$ to $[d]$ such that for each block B of G , $L_G|_{V(B)}$ is an injection. Similarly, we say that such a connected graph G is a *block d -labeled graph with labeling L_G* , and we call $L_G(v)$ the *label* of v . For convenience, we say a graph is *labeled* if it is a d -labeled graph or a block d -labeled graph for some d .

We frequently obtain an induced subgraph of a labeled graph by retaining the vertices with a given set of labels. For a d -labeled graph or a block d -labeled graph G and $I \subseteq [d]$, we denote by $G|_I$ the subgraph of G induced by the set of vertices having a label in I . Two d -labeled graphs G and H are *label-isomorphic* if there is a graph isomorphism from G to H that is label preserving. For two connected d -labeled graphs G and H with labelings L_G and L_H , we say H is *partially label-isomorphic* to G if H is label-isomorphic to $G|_{L_H(V(H))}$. We use analogous notation and terminology for block d -labeled graphs.

2.2 Treewidth

A *tree decomposition* of a graph G is a pair (T, \mathcal{B}) consisting of a tree T and a family $\mathcal{B} = \{B_t\}_{t \in V(T)}$ of sets $B_t \subseteq V(G)$, called *bags*, satisfying the following three conditions:

1. $V(G) = \bigcup_{t \in V(T)} B_t$.
2. For every edge uv of G , there exists a node t of T such that $u, v \in B_t$.
3. For $t_1, t_2, t_3 \in V(T)$, $B_{t_1} \cap B_{t_3} \subseteq B_{t_2}$ whenever t_2 is on the path from t_1 to t_3 in T .

The *width* of a tree decomposition (T, \mathcal{B}) is $\max\{|B_t| - 1 : t \in V(T)\}$. The *treewidth* of G is the minimum width over all tree decompositions of G . A *path decomposition* is a tree decomposition (P, \mathcal{B}) where P is a path. The *pathwidth* of G is the minimum width over all path decompositions of G . We denote a path decomposition (P, \mathcal{B}) as $(B_{v_1}, \dots, B_{v_t})$, where P is a path $v_1 v_2 \dots v_t$.

To design a dynamic programming algorithm, we use a convenient form of a tree decomposition known as a nice tree decomposition. A tree T is said to be *rooted* if it has a specified node called the *root*. Let T be a rooted tree with root node r . A node t of T is called a *leaf* node if it has degree one and it is not the root. For two nodes t_1 and t_2 of T , t_1 is a *descendant* of t_2 if the unique path from t_1 to r contains t_2 . If a node t_1 is a descendant of a node t_2 and $t_1 t_2 \in E(T)$, then t_1 is called a *child* of t_2 .

A tree decomposition $(T, \mathcal{B} = \{B_t\}_{t \in V(T)})$ is a *nice tree decomposition* with root node $r \in V(T)$ if T is a rooted tree with root node r , and every node t of T is one of the following:

1. *leaf node*: t is a leaf of T and $B_t = \emptyset$.
2. *introduce node*: t has exactly one child t' and $B_t = B_{t'} \cup \{v\}$ for some $v \in V(G) \setminus B_{t'}$.
3. *forget node*: t has exactly one child t' and $B_t = B_{t'} \setminus \{v\}$ for some $v \in B_{t'}$.
4. *join node*: t has exactly two children t_1 and t_2 , and $B_t = B_{t_1} = B_{t_2}$.

► **Theorem 6** (Bodlaender et al. [2]). *Given an n -vertex graph G and a positive integer k , one can either output a tree decomposition of G with width at most $5k + 4$, or correctly answer that the treewidth of G is larger than k , in time $2^{\mathcal{O}(k)}n$.*

► **Lemma 7** (folklore; see Lemma 7.4 in [5]). *Given a tree decomposition of an n -vertex graph G of width w , one can construct a nice tree decomposition (T, \mathcal{B}) of width w with $|V(T)| = \mathcal{O}(wn)$ in time $\mathcal{O}(k^2 \cdot \max(|V(T)|, |V(G)|))$.*

2.3 Boundaried graphs

For a graph G and $S \subseteq V(G)$, the pair (G, S) is called a *boundaried graph*. If G is a d -labeled graph or a block d -labeled graph, then we simply say that (G, S) is a d -labeled graph or a block d -labeled graph respectively, as S indicates that (G, S) is a boundaried graph. Two labeled graphs (G, S) and (H, S) are said to be *compatible* if $V(G - S) \cap V(H - S) = \emptyset$, $G[S] = H[S]$, and G and H have the same labels on S . For two compatible labeled graphs (G, S) and (H, S) , the *sum* of two graphs is the graph obtained from the disjoint union of G and H by identifying each vertex in S and removing an edge if multiple edges appear, and is denoted by $(G, S) \oplus (H, S)$. We also denote by $L_G \oplus L_H$ the function from the vertex set of $(G, S) \oplus (H, S)$ to $[d]$ where for $v \in V(G) \cup V(H)$, $(L_G \oplus L_H)(v) = L_G(v)$ if $v \in V(G)$ and $(L_G \oplus L_H)(v) = L_H(v)$ otherwise. Notice that $L_G \oplus L_H$ is not necessary a d -labeling or a block d -labeling of $G \oplus H$.

When we study BOUNDED \mathcal{P} -BLOCK VERTEX DELETION, we will deal with special types of blocks in boundaried graphs. A block of a graph is called *non-trivial* if it has at least two vertices. For a boundaried graph (G, S) , a block B of G is called an *S -block* if $G[V(B) \cap S]$ contains a non-trivial block of $G[S]$. Note that every non-trivial block of $G[S]$ is contained in a unique S -block of G because two distinct blocks share at most one vertex. For a boundaried graph (G, S) , let $\text{Pair}(G, S)$ be the set of all pairs (v, B) where B is a non-trivial block of $G[S]$ and $v \in V(B)$, and let $\text{Part}(G, S)$ be the partition of the set of connected components of $G[S]$ such that for two connected components C_1 and C_2 of $G[S]$, C_1 and C_2 are contained in the same part of $\text{Part}(G, S)$ if and only if they are contained in the same connected component of G . We use the following observation:

► **Lemma 8.** *For a boundaried graph (G, S) , $|\text{Pair}(G, S)| \leq 2|S|$.*

Proof. Let A be the set of all cut vertices of $G[S]$. For a vertex v in $S \setminus A$, v is contained in a unique block of $G[S]$, and thus the number of pairs $(v, B) \in \text{Pair}(G, S)$ where $v \in S \setminus A$ is at most $|S \setminus A|$. Consider a tree T on the union of A and the set \mathcal{B} of blocks of $G[S]$ where for $v \in A$ and $B \in \mathcal{B}$, $vB \in E(T)$ if and only if $v \in V(B)$. This tree T is sometimes called the block-cut tree of $G[S]$. Note that $|\mathcal{B}| \leq |S|$ and thus $|E(T)| = |A| + |\mathcal{B}| - 1 \leq |A| + |S|$. As there is a bijection between $E(T)$ and the pairs $(v, B) \in \text{Pair}(G, S)$ with $v \in A$, we conclude that $|\text{Pair}(G, S)| \leq |S \setminus A| + |A| + |S| \leq 2|S|$. ◀

2.4 Partitions of a set

For a set S and a set \mathcal{X} of subsets of S , let $\text{Inc}(S, \mathcal{X})$ be the bipartite graph on the bipartition (S, \mathcal{X}) where for $v \in S$ and $X \in \mathcal{X}$, v and X are adjacent in $\text{Inc}(S, \mathcal{X})$ if and only if $v \in X$. This is sometimes called the incidence graph of a hypergraph, and ‘Inc’ stands for the incidence graph.

For partitions \mathcal{X}_1 , and \mathcal{X}_2 of a set S , \mathcal{X}_1 is a *coarsening* of \mathcal{X}_2 if every two elements in the same part of \mathcal{X}_2 are in the same part of \mathcal{X}_1 , and we denote by $\mathcal{X}_1 \uplus \mathcal{X}_2$ the common coarsening of \mathcal{X}_1 and \mathcal{X}_2 with the maximum number of parts. For instance, if $\mathcal{X}_1 = \{\{1\}, \{2, 3\}, \{4\}\}$ and $\mathcal{X}_2 = \{\{1, 2\}, \{3\}, \{4\}\}$, then both $\{\{1, 2, 3\}, \{4\}\}$ and $\{\{1, 2, 3, 4\}\}$ are common coarsenings of \mathcal{X}_1 and \mathcal{X}_2 , and $\{\{1, 2, 3\}, \{4\}\} = \mathcal{X}_1 \uplus \mathcal{X}_2$.

3 Sums of two boundaried chordal graphs

In this section, we present two propositions which describe sufficient conditions for when, given a chordal labeled graph Q , the sum of two given labeled graphs, each partially label-isomorphic to Q , is also partially label-isomorphic to Q .

► **Lemma 9.** *Let F be a connected graph and let Q be a connected d -labeled chordal graph with a d -labeling L_Q . Let $L_F : V(F) \rightarrow [d]$ be a function with $L_F(V(F)) \subseteq L_Q(V(Q))$ and let μ be the function from $V(F)$ to $V(Q)$ mapping $v \in V(F)$ to the vertex $w \in V(Q)$ with $L_F(v) = L_Q(w)$ such that for every induced path $p_1 \cdots p_m$ in F of length one or two, $L(p_1), \dots, L(p_m)$ are pairwise distinct and $\mu(p_1) \cdots \mu(p_m)$ is an induced path of Q . Then L_F is a d -labeling of F and F is partially label-isomorphic to Q .*

Proof. We claim that L_F is an injection; that is, it is a d -labeling.

Claim 1. F has no two vertices v and w with $L_F(v) = L_F(w)$.

Proof. Suppose that F has two distinct vertices v and w with $L_F(v) = L_F(w)$. Since F is connected, there is a path from v to w in F . Let us choose such vertices v and w with minimum distance in F , and let $P = p_1 p_2 \cdots p_x$ be a shortest path from $v = p_1$ to $w = p_x$ in F . Note that P is an induced path, and by the assumption, $x \geq 4$ and $\mu(p_1)\mu(p_2)\mu(p_3)$ is an induced path in Q . This further implies that p_4 cannot have the same label as one of p_1, p_2, p_3 . Thus, we have that $x \geq 5$.

Let $y \in \{4, \dots, x-1\}$ be the smallest integer such that $\mu(p_y)$ is adjacent to one of $\mu(p_1), \dots, \mu(p_{y-3})$. Such an integer exists as $\mu(p_1) = \mu(p_x)$, so $\mu(p_{x-1})$ is adjacent to $\mu(p_1)$, and $\mu(p_i)\mu(p_{i+1})\mu(p_{i+2})$ is an induced path for each $1 \leq i \leq x-2$. Let $\mu(p_z)$ be such a neighbor of $\mu(p_y)$ with maximum z . Therefore, $\mu(p_z)\mu(p_{z+1}) \cdots \mu(p_y)\mu(p_z)$ is an induced cycle of length at least 4, which contradicts the assumption that Q is chordal. ◀

Now, we show that μ preserves the adjacency relation.

Claim 2. For each $v, w \in V(F)$, $vw \in E(F)$ if and only if $\mu(v)\mu(w) \in E(Q)$.

Proof. Suppose there are two vertices v and w in F such that the adjacency between v and w in F is different from the adjacency between $\mu(v)$ and $\mu(w)$ in Q . When $vw \in E(F)$, $\mu(v)$ is adjacent to $\mu(w)$ in Q by the assumption. We may assume that $vw \notin E(F)$ and $\mu(v)\mu(w) \in E(Q)$. We choose such vertices v and w with minimum distance between v and w in F . Let $P = p_1 p_2 \cdots p_x$ be a shortest path from $v = p_1$ to $w = p_x$ in F .

Note that $p_1 p_2 \cdots p_x$ is an induced path, and thus $x \geq 4$ by the assumption. By the minimality of the distance between v and w , each of $\mu(p_1)\mu(p_2) \cdots \mu(p_{x-1})$ and $\mu(p_2)\mu(p_3) \cdots \mu(p_x)$

is an induced path in Q . Therefore, $\mu(p_1)\mu(p_2)\cdots\mu(p_x)\mu(p_1)$ is an induced cycle of length at least four in Q , contradicting the assumption that Q is chordal. ◀

We conclude that F is partially label-isomorphic to Q . ◀

Notice that if we remove the condition that Q is chordal, then Lemma 9 does not hold. To see this, assume that H is an induced cycle of length six where labels 1, 2, 3, 4, 5, 6 are given in cyclic order, and G is the graph obtained from H by adding an edge between vertices with labels 3 and 6. Then the function μ from $V(H)$ to $V(G)$ preserving the labels satisfies the conditions of Lemma 9, but H is not partially label-isomorphic to G .

For a connected d -labeled graph Q , a d -labeled graph (G, S) with a labeling L_G is *component-wise partially label-isomorphic to Q* if every connected component C of G intersecting S is partially label-isomorphic to Q . For two compatible d -labeled graphs (G, S) and (H, S) with labelings L_G and L_H respectively, we say (G, S) and (H, S) are *component-wise Q -compatible* if

1. (G, S) and (H, S) are component-wise partially label-isomorphic to Q ; and
2. for every vertex v in S , $L_G(N_G(v) \setminus S) \cap L_H(N_H(v) \setminus S) = \emptyset$, and for $\ell_1 \in L_G(N_G(v) \setminus S)$ and $\ell_2 \in L_H(N_H(v) \setminus S)$, the vertices in Q with labels ℓ_1 and ℓ_2 are not adjacent.

► **Proposition 10.** *Let Q be a connected d -labeled chordal graph. Let (G, S) and (H, S) be d -labeled graphs, with d -labelings L_G and L_H respectively, such that they are component-wise Q -compatible and $(G, S) \oplus (H, S)$ is connected. Then $L_G \oplus L_H$ is a d -labeling of $(G, S) \oplus (H, S)$ and $(G, S) \oplus (H, S)$ is partially label-isomorphic to Q .*

Proof. Let $F := (G, S) \oplus (H, S)$ and $L := L_G \oplus L_H$. Since (G, S) and (H, S) are component-wise partially label-isomorphic to Q , we have $L(V(F)) \subseteq L_Q(V(Q))$. Let μ be the function from $V(F)$ to $V(Q)$ where for each $v \in V(F)$, $L(v) = L_Q(\mu(v))$. The function μ is uniquely determined, because for each label $\ell \in L_Q(V(Q))$, Q has a unique vertex with the label ℓ . Since every edge uv of F is contained in one of G or H , $L(u) \neq L(v)$ and $\mu(u)\mu(v) \in E(Q)$.

To apply Lemma 9, it is sufficient to prove the following:

Claim. Let $p_1p_2p_3$ be an induced path of length two in F . Then, $L(p_1)$, $L(p_2)$, and $L(p_3)$ are pairwise distinct, and $\mu(p_1)\mu(p_2)\mu(p_3)$ is an induced path.

Proof. Since (G, S) and (H, S) are component-wise partially label-isomorphic to Q , if all of p_1, p_2, p_3 are contained in G or H , then they have distinct labels and $F[\{p_1, p_2, p_3\}]$ is label-isomorphic to $Q|_{L(\{p_1, p_2, p_3\})}$. We may assume that $\{p_1, p_2, p_3\} \cap V(G - S) \neq \emptyset$ and $\{p_1, p_2, p_3\} \cap V(H - S) \neq \emptyset$. Without loss of generality, we may assume that $p_1 \in V(G - S)$, $p_2 \in S$, and $p_3 \in V(H - S)$. Since (G, S) and (H, S) are Q -compatible, $L(p_1) \neq L(p_3)$ and $\mu(p_1)\mu(p_3) \notin E(Q)$. Therefore, $\mu(p_1)\mu(p_2)\mu(p_3)$ is an induced path, as required. ◀

By Lemma 9, we conclude that F is partially label-isomorphic to Q . ◀

We prove a similar proposition related to the BOUNDED \mathcal{P} -BLOCK VERTEX DELETION problem. For the block version, it turns out that we need additional conditions. The S -blocks of G or H will have the same role as the connected components of G or H in Proposition 10. For a biconnected d -labeled graph Q , we say a block d -labeled graph (G, S) with a labeling L_G is *block-wise partially label-isomorphic to Q* if every S -block B of G is partially label-isomorphic to Q . For two compatible block d -labeled graph (G, S) and (H, S) with labelings L_G and L_H respectively, we say (G, S) and (H, S) are *block-wise Q -compatible* if

1. (G, S) and (H, S) are block-wise partially label-isomorphic to Q ; and

2. for every $(v, B) \in \text{Pair}(G, S)$ and S -blocks B_1 and B_2 of G and H respectively, $L_G(N_{B_1}(v) \setminus S) \cap L_H(N_{B_2}(v) \setminus S) = \emptyset$, and for $\ell_1 \in L_G(N_{B_1}(v) \setminus S)$ and $\ell_2 \in L_H(N_{B_2}(v) \setminus S)$, the vertices in Q with labels ℓ_1 and ℓ_2 are not adjacent.

► **Proposition 11.** *Let Q be a 2-connected d -labeled chordal graph. Let (G, S) and (H, S) be block d -labeled graphs with labelings L_G and L_H respectively, and the set \mathcal{C} of all connected components of $G[S]$ such that*

1. $(G, S) \oplus (H, S)$ contains a non-trivial block of $G[S]$;
2. every S -block B of (G, S) or (H, S) is partially label-isomorphic to Q ;
3. for every pair $(v, B) \in \text{Pair}(G, S)$, and the S -blocks B_1 and B_2 of G and H containing B respectively, $L_G(N_{B_1}(v) \setminus S) \cap L_H(N_{B_2}(v) \setminus S) = \emptyset$, and for $\ell_1 \in L_G(N_{B_1}(v) \setminus S)$ and $\ell_2 \in L_H(N_{B_2}(v) \setminus S)$, the vertices in Q with labels ℓ_1 and ℓ_2 are not adjacent; and
4. $\text{Inc}(\mathcal{C}, \text{Part}(G, S) \cup \text{Part}(H, S))$ has no cycles.

Then $L_G \oplus L_H$ is a block d -labeling of $(G, S) \oplus (H, S)$ and $(G, S) \oplus (H, S)$ is partially label-isomorphic to Q .

In contrast to Proposition 10, there is a special case for the block version which does not directly force the condition that for every induced path $p_1 p_2 p_3$ of F , $L(p_1), L(p_2), L(p_3)$ are pairwise distinct. Suppose that $p_1 p_2 p_3$ is an induced path in G where p_2 is a cut vertex of (G, S) contained in S . Observe that p_1 and p_3 do not necessarily have distinct labels since they are not contained in the same S -block of (G, S) . In this case, we need to find another path from p_1 to p_3 in $(G, S) \oplus (H, S)$ that can be used to verify that $L(p_1) \neq L(p_3)$.

Proof of Proposition 11. Let $F := (G, S) \oplus (H, S)$ and $L := L_G \oplus L_H$. If F is contained in G or H , then it is clear because (G, S) and (H, S) are block-wise partially label-isomorphic to Q . We may assume that $V(F - H)$ and $V(F - G)$ are non-empty. This implies that F is 2-connected. We check that every edge of F is contained in some S -block of G or H .

Claim 1. For every edge uv of F , u and v are contained in some S -block of G or H .

Proof. Let $uv \in E(F)$. If $u, v \in S$, then it is clear. We may assume that one of u and v is contained in $F - S$. By symmetry, we may assume that $\{u, v\} \cap V(G - S) \neq \emptyset$. Without loss of generality, let us assume that $v \in V(G - S)$.

Let C_v be the connected component of G containing v . As $V(H - S) \neq \emptyset$, there is a vertex $w \in V(H - S)$. Let C_w be the connected component of H containing w . Since $\text{Inc}(\mathcal{C}, \text{Part}(G, S) \cup \text{Part}(H, S))$ has no cycles and is connected, there is a unique path from C_v to C_w . Let D be the connected component of $F[S]$ that is on the path from C_v to C_w and is adjacent to C_v in $\text{Inc}(\mathcal{C}, \text{Part}(G, S) \cup \text{Part}(H, S))$.

Since F is 2-connected, there are two internally vertex-disjoint paths from $\{u, v\}$ to w . In these paths, we choose vertices p_1, p_2 that first meet D , and let P_1, P_2 be the subpaths from u, v to p_1, p_2 , respectively. Let Q be a path from p_1 to p_2 in D . Observe that $G[V(P_1) \cup V(P_2) \cup V(Q)]$ is a cycle of length at least 3, and it contains a non-trivial block of $F[S]$. Thus, u, v are contained in some S -block of G . ◀

Claim 1 implies that for every edge uv of F , $L(u) \neq L(v)$ and $\mu(u)\mu(v)$ is an edge of Q . Moreover, since $(G, S) \oplus (H, S)$ is 2-connected and (G, S) and (H, S) are block-wise partially label-isomorphic to Q , we have $L(V(F)) \subseteq L_Q(V(Q))$. Let μ be the function from $V(F)$ to $V(Q)$ where for each $v \in V(F)$, $L(v) = L_Q(\mu(v))$. It is sufficient to prove the following:

Claim 2. Let $p_1 p_2 p_3$ be an induced path of length two in F . Then, $L(p_1), L(p_2)$, and $L(p_3)$ are pairwise distinct, and $\mu(p_1)\mu(p_2)\mu(p_3)$ is an induced path.

Proof. Since (G, S) and (H, S) are block-wise partially label-isomorphic to Q , if all of p_1, p_2, p_3 are contained in some S -block of G or H , then they have distinct labels, and $F[\{p_1, p_2, p_3\}]$ is label-isomorphic to $Q|_{L(\{p_1, p_2, p_3\})}$. We may assume that they are not contained in the same S -block of G or H . By **Claim 1**, for each $i \in \{1, 2\}$, there is an S -block of G or H containing p_i and p_{i+1} . Let B be the S -block of G or H containing p_1 and p_2 , and let B' be the S -block of G or H containing p_2 and p_3 . When both p_i and p_{i+1} are contained in S for some $i \in \{1, 2\}$, we can freely choose an S -block from G or H containing p_i and p_{i+1} . By the assumption, $B \neq B'$. We can observe that $p_2 \in S$, otherwise, G is not 2-connected because $\text{Inc}(\mathcal{C}, \text{Part}(G, S) \cup \text{Part}(H, S))$ has no cycles. Let C be the connected component of $F[S]$ containing p_2 . Let U_1, \dots, U_p be the set of all induced subgraphs of C consisting of p_2 and one of the connected components of $C - p_2$.

Since B and B' are S -blocks, each of B and B' intersects at least two vertices of some subgraphs in $\{U_1, \dots, U_p\}$. Let $W_1 - W_2 - \dots - W_m$ be the shortest sequence of $\{U_1, \dots, U_p\}$ such that

- B intersects at least two vertices of W_1 , and B' intersects at least two vertices of W_m , and
- for each $i \in \{1, \dots, m-1\}$, there is a path from $W_i - p_2$ to $W_{i+1} - p_2$ in G or H .

Such a sequence always exists as F is 2-connected, and thus $F - p_2$ is connected. Let P_0 be a shortest path from p_1 to W_1 , let P_m be a shortest path from p_3 to W_m , and for each $i \in \{1, \dots, m-1\}$, let P_i be the shortest path from $W_i - p_2$ to $W_{i+1} - p_2$ in G or H . Let w_0 be the end vertex of P_0 on W_1 , let v_m be the end vertex of P_m on W_m , and for each $i \in \{1, \dots, m-1\}$, let v_i and w_i be the end vertices of P_i where $v_i \in V(P_i \cap W_i)$ and $w_i \in V(P_i \cap W_{i+1})$. Since (G, S) and (H, S) are block-wise partially label-isomorphic to Q , every S -block of G or H is chordal. From this, we may assume that for each $i \in \{1, \dots, m\}$, w_{i-1} and v_i are contained in the unique block of $F[S]$ containing p_2 in W_i . For each $i \in \{1, \dots, m\}$, let Q_i be the path from w_{i-1} to v_i in $W_i - p_2$. Finally, let $Q = q_1 q_2 \dots q_\ell$ be a shortest path from p_1 to p_3 on $P_0 \cup Q_1 \cup P_1 \cup \dots \cup Q_m \cup P_m$.

Observe that for each $i \in \{1, \dots, \ell-2\}$, q_i, q_{i+1}, q_{i+2} are contained in the same S -block of G or H , or there is a non-trivial block of $F[S]$ where q_i and q_{i+2} are contained in the S -blocks of G and H containing the block. Since (G, S) and (H, S) are block-wise Q -compatible, we can deduce that for each $i \in \{1, \dots, \ell-2\}$, $L(q_i), L(q_{i+1}), L(q_{i+2})$ are pairwise distinct, and $\mu(q_i)\mu(q_{i+1})\mu(q_{i+2})$ is an induced path of Q . Using the same argument in Lemma 9, we can show that $L(q_1), \dots, L(q_\ell)$ are pairwise distinct and $\mu(q_1)\mu(q_2) \dots \mu(q_\ell)$ is an induced path of Q . In particular, $L(p_1)$ and $L(p_3)$ are distinct and $\mu(p_1)$ and $\mu(p_3)$ are not adjacent in Q , as required. ◀

By Lemma 9, we conclude that F is partially label-isomorphic to Q . ◀

4 BOUNDED \mathcal{P} -COMPONENT VERTEX DELETION when \mathcal{P} is chordal and hereditary

In this section, we prove Theorem 3, which is restated below.

► **Theorem 12.** *Let \mathcal{P} be a class of graphs that is chordal, hereditary, and recognizable in polynomial time. Then BOUNDED \mathcal{P} -COMPONENT VERTEX DELETION can be solved in time $2^{\mathcal{O}(wd^2)} k^2 n$ on graphs with n vertices and treewidth w .*

As discussed earlier, we consider the target graphs as d -labeled graphs. We depict a simple example in Fig. 1 showing that the number of possible attachments of d -labeled graphs

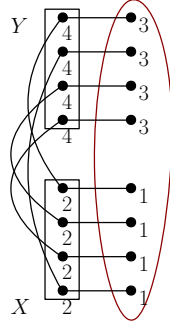

■ **Figure 1** An example showing that there are $2^{c \cdot w \log w}$ possible 4-labeled graphs intersecting a vertex set S of size w , for some constant c . In the worst case, it may have all distinct connections from X to Y corresponding to permutations on a set of size $w/2$.

on a vertex set of size w can be $2^{c \cdot w \log w}$, which is not good for obtaining a single-exponential algorithm. To use Proposition 10 properly, we introduce the notion of a *characteristic* of a d -labeled graph (G, S) . The main combinatorial argument in this section is that every two d -labeled \mathcal{P} -component graphs with the same characteristic have “equivalent mergeability”, which is proved in Theorem 13.

Let \mathcal{P} be a chordal and hereditary class of graphs and d be a positive integer. Let \mathcal{U}_d be the set of all connected d -labeled \mathcal{P} -component graphs, where each H in \mathcal{U}_d is equipped with a labeling L_H . For a d -labeled graph (G, S) with labeling L , a *characteristic* of (G, S) is a pair (g, h) of functions $g : S \rightarrow \mathcal{U}_d$ and $h : S \rightarrow 2^{[d]}$ satisfying the following:

1. for $v_1, v_2 \in S$ in the same connected component of G , $g(v_1) = g(v_2)$,
2. for $v \in S$, $h(v) = L(N_G(v) \setminus S)$,
3. for $v \in S$ in the connected component H of G , H is partially label-isomorphic to $g(v)$, and
4. for $v \in S$ in the connected component H of G and $w \in V(H) \setminus S$, $G[N_G[w]]$ is label-isomorphic to $g(v)[N_{g(v)}[z]]$ where z is the vertex in $g(v)$ with the label $L(w)$.

We say g satisfies the *coincidence condition* if g satisfies 1, and g satisfies the *complete condition* if g satisfies 4. We also say h satisfies the *neighborhood condition* if h satisfies 2. Let (G, S) be a d -labeled graph with a characteristic (g, h) . For a d -labeled graph (H, S) compatible with (G, S) , we say $(G, S) \oplus (H, S)$ *respects* (g, h) if, for every $v \in S$, the connected component of $(G, S) \oplus (H, S)$ containing v is label-isomorphic to $g(v)$. Using Proposition 10, we show two boundaried graphs with the same characteristic have equivalent mergeability.

► **Theorem 13.** *Let \mathcal{P} be a chordal and hereditary class of graphs, and let d be a positive integer. Let (G_1, S) , (G_2, S) , and (H, S) be d -labeled graphs with labelings L_{G_1}, L_{G_2}, L_H respectively, such that*

- for each $i \in \{1, 2\}$, (G_i, S) is compatible with (H, S) , and
- (G_1, S) and (G_2, S) have the same characteristic (g, h) .

If $(G_1, S) \oplus (H, S)$ respects (g, h) , then $(G_2, S) \oplus (H, S)$ also respects (g, h) .

Proof. Suppose $(G_1, S) \oplus (H, S)$ respects (g, h) . Let $v \in S$, let Q be the graph $g(v)$ with labeling L_Q , and let F be the connected component of $(G_2, S) \oplus (H, S)$ containing v . As a shortcut, we set $S_F := V(F) \cap S$. Note that each vertex of F inherits a label from at least

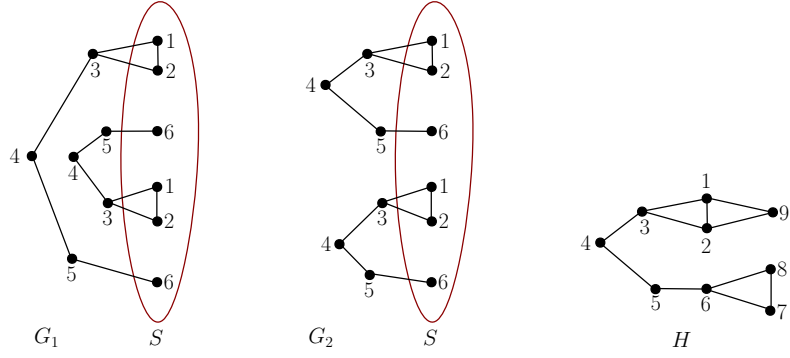

■ **Figure 2** Two d -labeled graphs (G_1, S) and (G_2, S) with the same characteristic (g, h) where for every $v \in S$, $g(v)$ is the graph H , and $h(v) = \{3\}$ or $\{5\}$.

one of G_2 and H . Let L_F be the function from $V(F)$ to $[d]$ that sends each vertex to this label; this is well-defined as (G_2, S) and (H, S) are compatible.

We claim that L_F is indeed a d -labeling of F , and F is label-isomorphic to Q . Since v was chosen arbitrarily, this implies that $(G_2, S) \oplus (H, S)$ respects (g, h) . We verify the conditions of Proposition 10 where F is considered as a sum of $(F \cap G_2, F_S)$ and $(F \cap H, F_S)$, and prove that L_F is a d -labeling of F and F is label-isomorphic to $Q|_{L_F(V(F))}$. To complete the proof, we additionally show that $L_Q(V(Q)) \subseteq L_F(V(F))$. Clearly F is connected.

Claim 1. For every $v' \in S_F$, $g(v') = g(v) = Q$.

Proof. Let $v_1, v_2 \in S_F$. By the definition of characteristics, if v_1, v_2 are contained in the same connected component of G_2 , then $g(v_1) = g(v_2)$. If v_1, v_2 are contained in the same connected component of H , then $g(v_1) = g(v_2)$ because $(G_1, S) \oplus (H, S)$ respects (g, h) . Therefore, $g(v') = g(v) = Q$ for every $v' \in S_F$, as F is connected. ◀

Claim 2. $F \cap G_2$ and $F \cap H$ are component-wise partially label-isomorphic to Q .

Proof. By **Claim 1** and the fact that (g, h) is a characteristic of (G_2, S) , $F \cap G_2$ is component-wise partially label-isomorphic to Q . By **Claim 1** and the fact that $(G_1, S) \oplus (H, S)$ respects (g, h) , $F \cap H$ is component-wise partially label-isomorphic to Q . ◀

Claim 3. $F \cap G_2$ and $F \cap H$ are component-wise Q -compatible.

Proof. Since $(G_1, S) \oplus (H, S)$ respects (g, h) , $N_{G_1}(v) \cap V(G_1 - S)$ and $N_H(v) \cap V(H - S)$ have disjoint sets of labels. As (G_1, S) and (G_2, S) have the same characteristic, $N_{G_1}(v) \cap V(G_1 - S)$ and $N_{G_2}(v) \cap V(G_2 - S)$ have the same set of labels, and thus $N_{G_2}(v) \cap V(G_2 - S)$ and $N_H(v) \cap V(H - S)$ have disjoint sets of labels. For $\ell_1 \in L_F(N_{G_2}(v) \cap V(G_2 - S))$ and $\ell_2 \in L_F(N_H(v) \cap V(H - S))$, the vertices in Q with labels ℓ_1 and ℓ_2 are not adjacent because there are no edges between $N_{G_1}(v) \cap V(G_1 - S)$ and $N_H(v) \cap V(H - S)$ in $(G_1, S) \oplus (H, S)$, and $(G_1, S) \oplus (H, S)$ respects (g, h) . ◀

Therefore, by Proposition 10, L_F is a d -labeling of F and F is partially label-isomorphic to Q . Lastly, we show that F and Q have the same set of labels, which implies that F is label-isomorphic to Q .

Claim 4. $L_Q(V(Q)) \subseteq L_F(V(F))$.

Proof. Suppose that there is a vertex v in Q such that F has no vertex with label $L_Q(v)$. We choose such a vertex v so that there exists $w \in V(Q)$ that is adjacent to v in Q where the label of w appears in F . We can choose such vertices v and w because Q is connected, $V(F) \neq \emptyset$, and $L_F(V(F)) \subseteq L_Q(V(Q))$. Let w' be the vertex in F with label $L_Q(w)$. If $w' \in V(G_2 - S)$, then by the definition of the characteristic, $F[N_F[w']]$ should be label-isomorphic to $Q[N_Q[w]]$. So, there is a neighbor of w' in F having the label $L_Q(v)$; a contradiction. If $w' \in V(H - S)$, then since the connected component of $(G_1, S) \oplus (H, S)$ containing w' is label-isomorphic to Q and all neighbors of w' in $(G_1, S) \oplus (H, S)$ are contained in H , this is also contradictory. So we may assume that w' is contained in S .

Again, we observe that the connected component of $(G_1, S) \oplus (H, S)$ containing w' is label-isomorphic to Q . We can also observe that every label appearing in the neighborhood of w' in $(G_1, S) \oplus (H, S)$ appears in the neighborhood of w' in $(G_2, S) \oplus (H, S)$ as well, because (G_1, S) and (G_2, S) have the same characteristic. This concludes the proof of the claim. ◀

We conclude that F is label-isomorphic to Q . ◀

Proof of Theorem 3. Using Theorem 6 and Lemma 7, we obtain a nice tree decomposition of width at most $5w + 4$ in time $\mathcal{O}(c^w \cdot n)$ for some constant c . Let $(T, \mathcal{B} = \{B_t\}_{t \in V(T)})$ be this nice tree decomposition with root node r . For each node t of T , let G_t be the subgraph of G induced by the union of all bags $B_{t'}$ where t' is a descendant of t . Let \mathcal{U}_d be the class of all connected d -labeled \mathcal{P} -component graphs, where each H in \mathcal{U}_d has a labeling L_H . Note that $|\mathcal{U}_d| \leq 2^{\binom{d}{2}}$.

For each node t of T , $X \subseteq B_t$, and a function $L : B_t \setminus X \rightarrow [d]$, let $\mathcal{F}(t, X, L)$ be the set of all pairs (g, h) of functions $g : B_t \setminus X \rightarrow \mathcal{U}_d$ and $h : B_t \setminus X \rightarrow 2^{[d]}$, and for each i with $0 \leq i \leq k$, let $c[t, X, L, i]$ be the family of all pairs (g, h) satisfying the following property: there exists $S \subseteq V(G_t) \setminus B_t$ with $|S| = i$, and a d -labeling L' of $G_t - (S \cup X)$ such that

- L is a restriction of L' on $B_t \setminus X$, and
- (g, h) is a characteristic of $(G_t - (S \cup X), B_t \setminus X)$.

Such a pair (S, L') is called a *partial solution* with respect to $c[t, X, L, i]$ and (g, h) . We will recursively compute the family $c[t, X, L, i]$ for every tuple of t, X, L , and i . For a pair $(g, h) \in c[t, X, L, i]$, (g, h) may correspond to two distinct partial solutions (S_1, L_1) and (S_2, L_2) where $|S_1| = |S_2| = i$. We observe in Theorem 13 that they have equivalent mergeability; that is, for every graph $(H, B_t \setminus X)$ compatible with $(G_t - (S_1 \cup X), B_t \setminus X)$, the boundaried graph $(G_t - (S_1 \cup X), B_t \setminus X) \oplus (H, B_t \setminus X)$ respects (g, h) if and only if $(G_t - (S_2 \cup X), B_t \setminus X) \oplus (H, B_t \setminus X)$ respects (g, h) . So, it is enough to store only one of these equivalent graphs, which the characteristic represents. At the final step, we will output the minimum integer $|X| + i$ such that $c[r, X, L, i] \neq \emptyset$ for some L . Clearly, BOUNDED \mathcal{P} -COMPONENT VERTEX DELETION is a YES-instance if and only if there is such a tuple with $|X| + i \leq k$.

Since $|\mathcal{U}_d| \leq 2^{\binom{d}{2}}$, we have

- $|\mathcal{F}(t, X, L)| \leq 2^{(w+1)\binom{d}{2}} \cdot 2^{(w+1)d} = 2^{\mathcal{O}(wd^2)}$, and
- $|c[t, X, L, i]| \leq 2^{(w+1)\binom{d}{2}} \cdot 2^{(w+1)d} = 2^{\mathcal{O}(wd^2)}$.

We describe how to update families $c[t, X, L, i]$ depending on the type of t , and prove the correctness of each procedure. We fix such a tuple. For each leaf node t , we assign $c[t, \emptyset, L, i] := \emptyset$ where L is an empty function. We assume that t is not a leaf node.

1) t is an introduce node with child t' :

Let v be the vertex in $B_t \setminus B_{t'}$. If $v \in X$, then $G_t - X = G_{t'} - (X \setminus \{v\})$ and $B_t \setminus X = B_{t'} \setminus (X \setminus \{v\})$. Thus, for every $(g, h) \in \mathcal{F}(t, X, L)$, $(g, h) \in c[t, X, L, i]$ if and only if $(g, h) \in c[t', X \setminus \{v\}, L, i]$. We set $c[t, X, L, i] := c[t', X \setminus \{v\}, L, i]$. In what follows, we assume that $v \notin X$. Let $L_{res} := L|_{B_{t'} \setminus X}$.

A pair $(g, h) \in \mathcal{F}(t, X, L)$ is called *valid* if it satisfies that

- for every v_1, v_2 in the same connected component of $G[B_t \setminus X]$, $g(v_1) = g(v_2)$,
- for every connected component C of $G[B_t \setminus X]$ and $w \in V(C)$, C is partially label-isomorphic to $g(w)$,
- $h(v) = \emptyset$, and
- for every neighbor w of v and $\ell \in h(w)$, $L(v) \notin h(w)$ and the vertices with labels $L(v)$ and ℓ in $g(v)$ are not adjacent.

For each $(g, h) \in \mathcal{F}(t, X, L)$, a pair $(g', h') \in \mathcal{F}(t', X, L_{res})$ is called a *restriction* of (g, h) if $g'(w) = g(w)$ and $h'(w) = h(w)$ for all $w \in B_{t'} \setminus X$. We show the following relation between $c[t, X, L, i]$ and $c[t', X, L_{res}, i]$:

Claim 1. For every valid pair $(g, h) \in \mathcal{F}(t, X, L)$, $(g, h) \in c[t, X, L, i]$ if and only if there exists a restriction (g', h') of (g, h) in $c[t', X, L_{res}, i]$.

Proof. The forward direction is straightforward since we can just ignore v . Suppose there exists a restriction (g', h') of (g, h) in $c[t', X, L_{res}, i]$. Let $(S, L_{t'})$ be a partial solution with respect to $c[t', X, L_{res}, i]$ and (g', h') . Let L_t be the function from $V(G_t - (X \cup S))$ to $[d]$ such that $L_t(v) = L(v)$ and $L_t(w) = L_{t'}(w)$ for every $w \in V(G_t - (X \cup S)) \setminus \{v\}$.

We first check that L_t is a d -labeling of $(G_t - (X \cup S), B_t \setminus X)$. Let F be a connected component of $(G_t - (X \cup S), B_t \setminus X)$. Since (g', h') is a characteristic of $(G_{t'} - (X \cup S), B_{t'} \setminus X)$ and (g, h) is valid, we can observe that $F \cap (G_{t'} - (X \cup S))$ and $F \cap G[B_{t'}]$ are component-wise Q -compatible. Thus, by Proposition 10, L_t is a d -labeling of $(G_t - (X \cup S), B_t \setminus X)$, and in particular, F is partially label-isomorphic to Q .

We show that (g, h) is a characteristic of $(G_t - (X \cup S), B_t \setminus X)$. From the assumptions that (g', h') is a characteristic of $(G_{t'} - (X \cup S), B_{t'} \setminus X)$ and (g, h) is valid, we can directly check g satisfies the coincidence and complete conditions, and h satisfies the neighborhood condition. Since g satisfies the coincidence condition, from the previous paragraph, we can observe that for every connected component H of $G_t - (X \cup S)$ containing a vertex in v_1 , H is partially label-isomorphic to $g(v_1)$. We conclude that $(G_t - (X \cup S), B_t \setminus X)$ is a d -labeled graph with the characteristic (g, h) . ◀

When $v \notin X$, we update $c[t, X, L, i]$ as follows. We choose $(g, h) \in \mathcal{F}(t, X, L)$. We can check whether (g, h) is valid or not in time $\mathcal{O}(wd^2)$. If it is not valid, then we skip it. We assume that (g, h) is valid. For every $(g', h') \in c[t', X, L_{res}, i]$, we test whether (g', h') is a restriction of (g, h) . It takes time $2^{\mathcal{O}(wd^2)}$ as $|c[t', X, L_{res}, i]| \leq 2^{\mathcal{O}(wd^2)}$. If there is at least one restriction of (g, h) in $c[t', X, L_{res}, i]$, then we add (g, h) to $c[t, X, L, i]$; otherwise, we do not. The correctness of this procedure follows from **Claim 1**, and we can complete $c[t, X, L, i]$ in time $2^{\mathcal{O}(wd^2)}$.

2) t is a forget node with child t' :

Let v be the vertex in $B_{t'} \setminus B_t$. For an extension L' of L on $B_{t'} \setminus X$, a pair $(g', h') \in \mathcal{F}(t', X, L')$ is called an *extension* of (g, h) with respect to L' if

1. for every $w \in B_t \setminus X$, $g'(w) = g(w)$,
2. for every neighbor w of v in $B_t \setminus X$, $h'(w) \cup \{L'(v)\} = h(w)$, and
3. for every non-neighbor w of v in $B_t \setminus X$, $h'(w) = h(w)$.

We show the following:

Claim 2. For every $(g, h) \in \mathcal{F}(t, X, L)$, $(g, h) \in c[t, X, L, i]$ if and only if one of the following holds:

1. $(g, h) \in c[t', X \cup \{v\}, L, i - 1]$.
2. There exists an extension L_{ext} of L on $B_{t'} \setminus X$ and an extension (g', h') of (g, h) in $c[t', X, L_{ext}, i]$ with respect to L_{ext} .

Proof. We first show the backwards direction. If $(g, h) \in c[t', X \cup \{v\}, L, i - 1]$, then clearly $(g, h) \in c[t, X, L, i]$, as we can put the vertex v into the deletion set. Suppose there exist an extension L_{ext} of L on $B_{t'} \setminus X$ and an extension (g', h') in $c[t', X, L_{ext}, i]$ with respect to L_{ext} . Let (S, L') be a partial solution with respect to $c[t', X, L_{ext}, i]$ and (g', h') . As (g', h') is an extension of (g, h) , (g, h) is a characteristic of $(G_t - (X \cup S), B_t \setminus X)$.

Now, suppose $(g, h) \in c[t, X, L, i]$. So there exists a partial solution (S, L_t) with respect to $c[t, X, L, i]$ and (g, h) . If $v \in S$, then (g, h) should exist in $c[t', X \cup \{v\}, L, i - 1]$, and this corresponds to the first case. We may assume $v \notin S$. Let $L_{ext} := L_t|_{B_{t'} \setminus X}$. We create a proper extension (g', h') of (g, h) .

Let $g'(v)$ be the graph in \mathcal{U}_d satisfying the following:

- If v is contained in the same connected component of $G_t - (X \cup S)$ as a vertex w in $B_t \setminus X$, then $g'(v) = g(w)$.
- Otherwise, we know that the connected component containing v is label-isomorphic to a graph in \mathcal{U}_d ; let $g'(v)$ be this graph.

Let $g'(w) = g(w)$ for $w \in B_t \setminus X$. Also, for $w \in B_{t'} \setminus X$, let $h'(w)$ be the set of labels that appear in $N_{G_{t'} - (S \cup X)}(w) \setminus B_{t'}$. Then

- for every neighbor w of v in $B_t \setminus X$, $h'(w) \cup \{L_{ext}(v)\} = h(w)$, and
- for every non-neighbor w of v in $B_t \setminus X$, $h'(w) = h(w)$.

Thus (g', h') is an extension of (g, h) , and it is in $c[t', X, L_{ext}, i]$, as required. ◀

We update $c[t, X, L, i]$ as follows. We choose $(g, h) \in \mathcal{F}(t, X, L)$. We can check whether $(g, h) \in c[t', X \cup \{v\}, L, i - 1]$ in time $2^{\mathcal{O}(wd^2)}$. If it is, then we add (g, h) to $c[t, X, L, i]$. Suppose that $(g, h) \notin c[t', X \cup \{v\}, L, i - 1]$. Now, for every possible extension L_{ext} of L by choosing a label for v , and for every $(g', h') \in c[t', X, L_{ext}, i]$, we test whether (g', h') is an extension of (g, h) . This takes time $2^{\mathcal{O}(wd^2)}$ as $|c[t', X, L_{ext}, i]| \leq 2^{\mathcal{O}(wd^2)}$. If there is at least one extension of (g, h) for some extension L_{ext} of L , then we add (g, h) to $c[t, X, L, i]$; otherwise, we do not add it. The correctness of this procedure follows from **Claim 2**, and in total, we can complete the table $c[t, X, L, i]$ in time $2^{\mathcal{O}(wd^2)}$.

3) t is a join node with two children t_1 and t_2 :

We show the following:

Claim 3. For every $(g, h) \in \mathcal{F}(t, X, L)$, $(g, h) \in c[t, X, L, i]$ if and only if there exist integers i_1, i_2 with $i_1 + i_2 = i$, $(g, h_1) \in c[t_1, X, L, i_1]$ and $(g, h_2) \in c[t_2, X, L, i_2]$ such that

- for each $w \in B_t \setminus X$, $h_1(w) \cap h_2(w) = \emptyset$ and $h(w) = h_1(w) \cup h_2(w)$, and for $\ell_1 \in h_1(w)$ and $\ell_2 \in h_2(w)$, the vertices with labels ℓ_1 and ℓ_2 in $g(w)$ are not adjacent.

Proof. The forward direction is straightforward. Suppose there exist integers i_1, i_2 with $i_1 + i_2 = i$ and two characteristics $(g, h_1) \in c[t_1, X, L, i_1]$ and $(g, h_2) \in c[t_2, X, L, i_2]$ as specified in the claim. For each $j \in \{1, 2\}$, let (S_j, L_j) be a partial solution with respect to $c[t_i, X, L, i_j]$ and (g, h_j) . Let L_t be the labeling of $G_t - (X \cup S_1 \cup S_2)$ obtained from each of L_1 and L_2 . We claim that $(G_t - (X \cup S_1 \cup S_2), B_t \setminus X)$ with the labeling L_t is a d -labeled graph with characteristic (g, h) . We verify the conditions of the definition of characteristics.

From the assumption that each (g, h_j) is a characteristic of $(G_{t_j} - (X \cup S_j), B_t \setminus X)$, we can directly check that g satisfies the coincidence and complete conditions and h satisfies the neighborhood condition. It remains to check that for every $v \in B_t \setminus X$ and the connected component H of $G_t - (X \cup S_1 \cup S_2)$ containing v , H is partially label-isomorphic to $g(v)$.

We consider H as the sum of $H \cap (G_{t_1} - (S \cup X_1))$ and $H \cap (G_{t_2} - (S \cup X_2))$ with the same boundary $V(H) \cap (B_t \setminus X)$. Clearly H is connected, and since g satisfies the coincidence condition, for every $v_1, v_2 \in V(H) \cap (B_t \setminus X)$, $g(v_1) = g(v_2)$. Let $Q := g(v)$. Since each (g, h_j) is a characteristic of $(G_{t_j} - (X \cup S_j), B_t \setminus X)$, each $H \cap (G_{t_i} - (S \cup X_i))$ is component-wise partially label-isomorphic to Q . Moreover, by the assumption that for $w \in B_t \setminus X$, $\ell_1 \in h_1(w)$, and $\ell_2 \in h_2(w)$, the vertices with labels ℓ_1 and ℓ_2 in $g(w)$ are not adjacent, $H \cap (G_{t_1} - (S \cup X_1))$ and $H \cap (G_{t_2} - (S \cup X_2))$ are component-wise Q -compatible. By Proposition 10, H is partially label-isomorphic to $g(v)$.

We conclude that (g, h) is a characteristic of $(G_t - (X \cup S_1 \cup S_2), B_t \setminus X)$. ◀

In the algorithm, choose a pair $(g, h) \in \mathcal{F}(t, X, L)$. For all integers i_1, i_2 with $i_1 + i_2 = i$, $(g, h_1) \in c[t_1, X, L, i_1]$ and $(g, h_2) \in c[t_2, X, L, i_2]$, we check whether for each $w \in B_t \setminus X$, $h_1(w) \cap h_2(w) = \emptyset$ and $h(w) = h_1(w) \cup h_2(w)$, and for $\ell_1 \in h_1(w)$ and $\ell_2 \in h_2(w)$, the vertices with labels ℓ_1 and ℓ_2 in $g(w)$ are not adjacent. If there is such a pair of characteristics, then we add (g, h) to $c[t, X, L, i]$; otherwise, we do not add anything to $c[t, X, L, i]$. We can complete the table $c[t, X, L, i]$ in time $2^{\mathcal{O}(wd^2)}k$ as $i \leq k$.

Total running time. We denote $|V(G)|$ by n . Note that the number of nodes in T is $\mathcal{O}(wn)$ by Lemma 7. For fixed $t \in V(T)$, there are at most 2^{w+1} possible choices for $X \subseteq B_t$, and for fixed $X \subseteq B_t$, there are at most d^{w+1} possible functions L on $B_t \setminus X$. Thus, there are $\mathcal{O}(n \cdot k \cdot \max(2, d)^{w+1})$ tables. In summary, the algorithm runs in time $\mathcal{O}(n \cdot k \cdot \max(2, d)^{w+1}) \cdot 2^{\mathcal{O}(wd^2)} \cdot k = 2^{\mathcal{O}(wd^2)}k^2n$. ◀

5 BOUNDED \mathcal{P} -BLOCK VERTEX DELETION when \mathcal{P} is a class of chordal graphs

In this section, we prove Theorem 1, restated below.

► **Theorem 14.** *Let \mathcal{P} be a class of graphs that is chordal, block-hereditary, and recognizable in polynomial time. Then BOUNDED \mathcal{P} -BLOCK VERTEX DELETION can be solved in time $2^{\mathcal{O}(wd^2)}k^2n$ on graphs with n vertices and treewidth w .*

We provide an overview of our approach for Theorem 1. Let (G, S) and (H, S) be two compatible block d -labeled \mathcal{P} -block graphs. Recall that S -blocks, $\text{Pair}(G, S)$, and $\text{Part}(G, S)$ were defined in Section 2.

1. We first focus on S -blocks of (G, S) . We follow the idea in the proofs of Theorems 3 and 13 for dealing with S -blocks. Specifically, for each non-trivial block of $G[S]$, we guess its final shape, and store the labelings of the vertices and their neighbors in the S -block of G containing it. We store these as a b -characteristic of (G, S) . Note that some vertices can be in more than one non-trivial block of $G[S]$, and we need to consider these blocks

separately. So, the natural domains for functions g and h are $\text{Pair}(G, S)$ rather than S . Using b -characteristics, we control S -blocks in $(G, S) \oplus (H, S)$.

2. By the procedure in (1), we may assume that every S -block of $(G, S) \oplus (H, S)$ is a \mathcal{P} -block graph with at most d vertices. Note that $(G, S) \oplus (H, S)$ still may have a chordless cycle. Let \mathcal{C} be the set of all connected components of $G[S]$. We show in Proposition 20 that $(G, S) \oplus (H, S)$ has a chordless cycle if and only if $\text{Inc}(\mathcal{C}, \text{Part}(G, S) \cup \text{Part}(H, S))$ has no cycles. To use this fact, we need to store $\text{Part}(G, S)$. If we store all such possible partitions, then, in the worst case, the number of such partitions can be $2^{c \cdot w \log w}$ for some constant c . To avoid storing all such partitions, we borrow the representative set technique for obtaining a $2^{\mathcal{O}(w)} \cdot n^{\mathcal{O}(1)}$ -algorithm for the FEEDBACK VERTEX SET problem from [1].

In Section 5.1, we formally define a *representative set*, and recall some necessary results. In Section 5.2, we define the notion of *b-characteristics*, analogous to characteristics used in Section 4. We prove the main result in Section 5.3.

5.1 Representative sets

Let S be a set, and let \mathcal{A} be a set of partitions of S . A subset \mathcal{A}' of \mathcal{A} is called a *representative set* if it satisfies that

- for every $\mathcal{X}_1 \in \mathcal{A}$ and every partition \mathcal{Y} of S where $\text{Inc}(S, \mathcal{X}_1 \cup \mathcal{Y})$ has no cycles, there exists a partition $\mathcal{X}_2 \in \mathcal{A}'$ such that $\text{Inc}(S, \mathcal{X}_2 \cup \mathcal{Y})$ has no cycles.

We need to compute a representative set for a family of partitions. To apply the ideas in [1], it is necessary to translate our problem to finding a pair of partitions $\mathcal{X}_1, \mathcal{X}_2$ where $\text{Inc}(S, \mathcal{X}_1 \cup \mathcal{X}_2)$ is connected. For the FEEDBACK VERTEX SET problem, the authors in [1] add one universal vertex to the given graph and deal with the size constraint on the vertex and edge sets of the obtained connected graph, using the fact that a connected graph T is a tree if and only if $|V(T)| = |E(T)| + 1$. In our setting, we argue by restricting the size of partitions in \mathcal{A} .

► **Lemma 15.** *Let S be a set and let $\mathcal{X}_1, \mathcal{X}_2$ be two partitions of S such that $\text{Inc}(S, \mathcal{X}_1 \cup \mathcal{X}_2)$ is connected. Then $\text{Inc}(S, \mathcal{X}_1 \cup \mathcal{X}_2)$ has no cycles if and only if $|\mathcal{X}_1| + |\mathcal{X}_2| = |S| + 1$.*

Proof. Let $H := \text{Inc}(S, \mathcal{X}_1 \cup \mathcal{X}_2)$. The result follows from the fact that $|V(H)| = |S| + |\mathcal{X}_1| + |\mathcal{X}_2|$, $|E(H)| = 2|S|$, and a connected graph H has no cycles if and only if $|E(H)| = |V(H)| - 1$. ◀

For a set S and a partition \mathcal{X} of S , a partition \mathcal{Y} of S is called a *1-coarsening* of \mathcal{X} if $\mathcal{Y} = \mathcal{X} \setminus \{X_1, \dots, X_m\} \cup \{X_1 \cup \dots \cup X_m\}$ for some $X_1, \dots, X_m \in \mathcal{X}$. Notice that the partition \mathcal{X} itself is a 1-coarsening of \mathcal{X} . We will use the following observation. For two partitions $\mathcal{X}_1, \mathcal{X}_2$ of a set S , the following are equivalent:

- $\text{Inc}(S, \mathcal{X}_1 \cup \mathcal{X}_2)$ has no cycles.
- There exists a 1-coarsening \mathcal{X}'_1 of \mathcal{X}_1 such that $\text{Inc}(S, \mathcal{X}'_1 \cup \mathcal{X}_2)$ is connected and has no cycles.

Such a 1-coarsening \mathcal{X}' can be obtained by taking one part of \mathcal{X} for each connected component of $\text{Inc}(S, \mathcal{X}_1 \cup \mathcal{X}_2)$ and unifying them into one part. Since the new part of \mathcal{X}'_1 would be a cut vertex of $\text{Inc}(S, \mathcal{X}'_1 \cup \mathcal{X}_2)$, there will not be an additional cycle in $\text{Inc}(S, \mathcal{X}'_1 \cup \mathcal{X}_2)$ while it is connected.

We explicitly describe a necessary subroutine, Algorithm 1.

Algorithm 1 REPARTITIONS(S, \mathcal{A})

Input: A set S and a family \mathcal{A} of partitions of S .

Output: A representative set \mathcal{R} of \mathcal{A} .

- 1: We compute the family \mathcal{A}' of all 1-coarsenings of partitions in \mathcal{A} .
 - 2: For each $1 \leq i \leq |S|$, let $\mathcal{A}_i := \{\mathcal{X} \in \mathcal{A}' : |\mathcal{X}| = i\}$ and let \mathcal{B}_i be the set of all partitions of S of size i .
 - 3: For each $1 \leq i, j \leq |S|$ with $i + j = |S| + 1$, we obtain a set \mathcal{R}_i from \mathcal{A}_i with respect to \mathcal{B}_j using Theorem 16.
 - 4: We take the set \mathcal{R} from $\bigcup_{1 \leq i \leq |S|} \mathcal{R}_i$ by taking the original partition before taking 1-coarsening, and output \mathcal{R} .
-

► **Theorem 16** ([1]; See also Theorem 11.11 in [5]). *Given two families of partitions \mathcal{A}, \mathcal{B} of a set S , one can in time $\mathcal{A}^{\mathcal{O}(1)}2^{\mathcal{O}(|S|)}$ find a set $\mathcal{A}' \subseteq \mathcal{A}$ of size at most $2^{|S|-1}$ such that for every $\mathcal{X}_1 \in \mathcal{A}$ and every $\mathcal{Y} \in \mathcal{B}$ such that $\text{Inc}(S, \mathcal{X}_1 \cup \mathcal{Y})$ is connected, there exists $\mathcal{X}_2 \in \mathcal{A}'$ such that $\text{Inc}(S, \mathcal{X}_2 \cup \mathcal{Y})$ is connected.*

► **Proposition 17.** *Given a family \mathcal{A} of partitions of a set S , Algorithm 1 outputs a representative set of \mathcal{A} of size at most $|S| \cdot 2^{|S|-1}$ in time $\mathcal{A}^{\mathcal{O}(1)}2^{\mathcal{O}(|S|)}$.*

Proof. Let \mathcal{R} be the output of Algorithm 1. Clearly, $\mathcal{R} \subseteq \mathcal{A}$, because we take the original partitions of $\bigcup_{1 \leq i \leq |S|} \mathcal{R}_i$ at the last step. Thus, it is sufficient to show that

- for every $\mathcal{X}_1 \in \mathcal{A}$ and every partition \mathcal{Y} of S where $\text{Inc}(S, \mathcal{X}_1 \cup \mathcal{Y})$ has no cycles, there exists a partition $\mathcal{X}_2 \in \mathcal{R}$ such that $\text{Inc}(S, \mathcal{X}_2 \cup \mathcal{Y})$ has no cycles.

To show this, let $\mathcal{X}_1 \in \mathcal{A}$ and \mathcal{Y} be partitions of S such that $\text{Inc}(S, \mathcal{X}_1 \cup \mathcal{Y})$ has no cycles. We know that there exists a 1-coarsening \mathcal{X}_2 of \mathcal{X}_1 such that $\text{Inc}(S, \mathcal{X}_2 \cup \mathcal{Y})$ is connected and has no cycles. This 1-coarsening \mathcal{X}_2 is obtained in Step 1. In Step 3, we obtain $\mathcal{R}_{|\mathcal{X}_2|}$, and there exists $\mathcal{X}_3 \in \mathcal{R}_{|\mathcal{X}_2|}$ such that $\text{Inc}(S, \mathcal{X}_3 \cup \mathcal{Y})$ is connected and has no cycles. Let \mathcal{X}_4 be the partition obtained from \mathcal{X}_3 by taking the original partition before taking 1-coarsening. We have that $\mathcal{X}_4 \in \mathcal{R}$ and $\text{Inc}(S, \mathcal{X}_4 \cup \mathcal{Y})$ has no cycles, as required. By Theorem 16, $|\mathcal{R}| \leq \sum_{1 \leq i \leq |S|} |\mathcal{R}_i| \leq |S| \cdot 2^{|S|-1}$ and Algorithm 1 runs in time $\mathcal{A}^{\mathcal{O}(1)}2^{\mathcal{O}(|S|)}$. ◀

We remark that Proposition 17 can also be obtained by applying the representative set technique for matroids developed by Fomin et al. [10], using the graphic matroid corresponding to $\text{Inc}(S, \mathcal{A})$.

5.2 b -characteristics

We fix a class of graphs that is block-hereditary and consists of only chordal graphs, and a positive integer d . Let \mathcal{U}_d be the set of all d -labeled biconnected \mathcal{P} -block graphs, where each H in \mathcal{U}_d has labeling L_H . For convenience, we write $g(v, B)$ and $h(v, B)$ instead of $g((v, B))$ and $h((v, B))$ for functions g and h defined on $\text{Pair}(G, S)$. For a block d -labeled graph (G, S) with a labeling L , a b -characteristic of (G, S) is a pair (g, h) of functions $g : \text{Pair}(G, S) \rightarrow \mathcal{U}_d$ and $h : \text{Pair}(G, S) \rightarrow 2^{[d]}$ satisfying the following:

1. for every $(v_1, B_1), (v_2, B_2) \in \text{Pair}(G, S)$ where B_1 and B_2 are contained in the same S -block of (G, S) , $g(v_1, B_1) = g(v_2, B_2)$,
2. for every $(v, B) \in \text{Pair}(G, S)$ and the S -block H of G containing B , $h(v, B) = L(N_H(v) \setminus S)$,

3. for every $(v, B) \in \text{Pair}(G, S)$ and the S -block H of G containing B , H is partially label-isomorphic to $g(v, B)$, and
4. for every $(v, B) \in \text{Pair}(G, S)$ and the S -block H of G containing B , and every $w \in V(H) \setminus S$, $H[N_H[w]]$ is label-isomorphic to $g(v, B)[N_{g(v, B)}[w]]$ where w is the vertex in $g(v, B)$ with label $L(w)$.

We say g satisfies the *coincidence condition* if g satisfies 1, and g satisfies the *complete condition* if g satisfies 4. We also say h satisfies the *neighborhood condition* if h satisfies 2. For a block d -labeled \mathcal{P} -block graph with a b -characteristic of (g, h) , we say that the sum $(G, S) \oplus (H, S)$ *respects* (g, h) if for each $(v, B) \in \text{Pair}(G, S)$, the S -block of $(G, S) \oplus (H, S)$ containing B is label-isomorphic to $g(v, B)$.

We prove an analogue of Theorem 13.

► **Theorem 18.** *Let \mathcal{P} be a class of graphs that is block-hereditary and consists of only chordal graphs, and let d be a positive integer. Let (G_1, S) , (G_2, S) , and (H, S) be three block d -labeled \mathcal{P} -block graphs and \mathcal{C} be the set of connected components of $G_2[S]$ such that*

- $\text{Inc}(\mathcal{C}, \text{Part}(G_2, S) \cup \text{Part}(H, S))$ has no cycles,
- for each $i \in \{1, 2\}$, (G_i, S) is compatible with (H, S) , and
- (G_1, S) and (G_2, S) have the same b -characteristic (g, h) .

If $(G_1, S) \oplus (H, S)$ is a block d -labeled \mathcal{P} -block graph that respects (g, h) , then $(G_2, S) \oplus (H, S)$ is a block d -labeled \mathcal{P} -block graph that respects (g, h) .

Before proving this, we prove a lemma about the transitive property of S -blocks. This is rather clear for the connected component version, but for the block version, we need an additional assumption that $\text{Inc}(\mathcal{C}, \text{Part}(G, S) \cup \text{Part}(H, S))$ has no cycles.

► **Lemma 19.** *Let \mathcal{P} be a class of graphs that is block-hereditary and consists of only chordal graphs, and let A be a set. Let (G, S) and (H, S) be two compatible block d -labeled chordal graphs, \mathcal{C} be the set of connected components of $G[S]$, and $g : \text{Pair}(G, S) \rightarrow A$ be a function such that*

- $\text{Inc}(\mathcal{C}, \text{Part}(G, S) \cup \text{Part}(H, S))$ has no cycles,
- for every $(v_1, B_1), (v_2, B_2) \in \text{Pair}(G, S)$ where B_1 and B_2 are contained in the same S -block of G , $g(v_1, B_1) = g(v_2, B_2)$, and
- for every $(v_1, B_1), (v_2, B_2) \in \text{Pair}(G, S)$ where B_1 and B_2 are contained in the same S -block of H , $g(v_1, B_1) = g(v_2, B_2)$.

If F is an S -block of $(G, S) \oplus (H, S)$ and $(v_1, B_1), (v_2, B_2) \in \text{Pair}(G, S)$ where $V(B_1), V(B_2) \subseteq V(F)$, then $g(v_1, B_1) = g(v_2, B_2)$.

Proof. Let F be an S -block of $(G, S) \oplus (H, S)$, and $(v, B) \in \text{Pair}(G, S)$ where $V(B) \subseteq V(F)$. It is sufficient to show that for every $(v', B') \in \text{Pair}(G, S)$ with $V(B') \subseteq V(F)$, $g(v', B') = g(v, B)$. Let $(v', B') \in \text{Pair}(G, S)$ with $V(B') \subseteq V(F)$. We may assume that $B \neq B'$ and F is 2-connected.

We first prove a base case where B and B' share a cut vertex of $G[S]$.

Claim 1. If B and B' share a cut vertex w of $G[S]$, then $g(v, B) = g(v', B')$.

Proof. Let C be the connected component of $G[S]$ containing B and B' , and let U_1, \dots, U_p be the set of all induced subgraphs of C consisting of w and one of the connected components of $C - w$. Let C_G and C_H be the connected components of G and H containing

C , respectively. Note that for each $i \in \{1, \dots, p\}$, there is a unique block of $G[S]$ in U_i containing w . We call it M_i . Since $B \neq B'$, B and B' are two distinct blocks of M_1, \dots, M_p .

Let $W_1 - W_2 - \dots - W_m$ be the shortest sequence of graphs in $\{U_1, \dots, U_p\}$ such that

- B and B' are unique blocks containing w in W_1 and W_m , respectively, and
- for each $i \in \{1, \dots, m-1\}$, there is a path from $W_i - w$ to $W_{i+1} - w$ in $G - w$ or $H - w$.

Such a sequence always exists as F is 2-connected and there is a path from $B - w$ to $B' - w$ in $(C_G \cup C_H) - w$. Clearly, for each $i \in \{1, \dots, m-1\}$, there is an S -block of G or H containing the unique blocks containing p in W_i and W_{i+1} . From this, we can observe that for every unique block B'' containing p in W_1, \dots, W_m , $g(w, B'') = g(v, B)$ and, in particular, we have $g(v', B') = g(v, B)$, as required. ◀

Let A and A' be the connected components of $G[S]$ containing B and B' respectively. Since $\text{Inc}(\mathcal{C}, \text{Part}(G, S) \cup \text{Part}(H, S))$ has no cycles and F is connected, there is a unique path from A to A' in $\text{Inc}(\mathcal{C}, \text{Part}(G, S) \cup \text{Part}(H, S))$. Let $A = A_1 - A_2 - \dots - A_m = A'$ be the sequence of connected components of $G[S]$ that appear on the unique path from A to A' in $\text{Inc}(\mathcal{C}, \text{Part}(G, S) \cup \text{Part}(H, S))$. We prove the statement by induction on m . In the case when $A = A'$, it is easy to verify using **Claim 1**, by induction on the number of cut vertices between B and B' in A . We may assume that $m \geq 2$, and the statement holds for every positive integer smaller than m .

Since F is 2-connected, there are two vertex-disjoint paths P_1 and P_2 from B to B' in F . Furthermore, for each $i \in \{1, 2\}$, there is a subpath P'_i of P_i whose end vertices are in A_{m-1}, A_m , and other vertices are not in S . Let Q_1 be a path in A_m between two end vertices of P'_1 and P'_2 in A_m , and let Q_2 be a path in A_{m-1} between two end vertices of P'_1 and P'_2 in A_{m-1} . Clearly $((G, S) \oplus (H, S))[V(P'_1) \cup V(P'_2) \cup V(Q_1) \cup V(Q_2)]$ is a cycle of G or H , and as P_1 and P_2 are contained in F , all vertices in Q_1 and Q_2 are in F as well. We choose two blocks B_{m-1} in A_{m-1} and B_m in A_m containing at least two vertices of Q_2 and Q_1 , respectively. Let $v_{m-1} \in V(B_{m-1})$ and $v_m \in V(B_m)$. By the induction hypothesis, $g(v_{m-1}, B_{m-1}) = g(v, B)$, and since B_{m-1} and B_m are contained in the same S -block of G or H , we have $g(v_m, B_m) = g(v, B)$. Finally, by applying the same argument for the case when $A = A'$, we can conclude that $g(v', B') = g(v_m, B_m)$. ◀

As mentioned earlier, the fact that $(G, S) \oplus (H, S)$ respects (g, h) does not guarantee that $(G, S) \oplus (H, S)$ is a \mathcal{P} -block graph whose blocks contain at most d vertices. In Proposition 20, we show that if $(G, S) \oplus (H, S)$ respects (g, h) and $\text{Inc}(\mathcal{C}, \text{Part}(G, S) \cup \text{Part}(H, S))$ has no cycles, then $(G, S) \oplus (H, S)$ is a block d -labeled \mathcal{P} -block graph.

► **Proposition 20.** *Let \mathcal{P} be a class of graphs that is block-hereditary and consists of only chordal graphs, and let d be a positive integer. Let (G, S) and (H, S) be two compatible block d -labeled \mathcal{P} -block graphs with labelings L_G and L_H respectively, and (g, h) be a b -characteristic of (G, S) such that $(G, S) \oplus (H, S)$ respects (g, h) . Let \mathcal{C} be the set of all connected components of $G[S]$. The following are equivalent:*

1. $(G, S) \oplus (H, S)$ is a block d -labeled \mathcal{P} -block graph.
2. $(G, S) \oplus (H, S)$ is chordal.
3. $\text{Inc}(\mathcal{C}, \text{Part}(G, S) \cup \text{Part}(H, S))$ has no cycles.

Proof. (1 \Rightarrow 2). This direction is trivial as \mathcal{P} consists of only chordal graphs.

(2 \Rightarrow 3). Suppose that $\text{Inc}(\mathcal{C}, \text{Part}(G, S) \cup \text{Part}(H, S))$ has a cycle $C_1 - A_1 - C_2 - A_2 - \dots - C_n - A_n - C_1$ where $C_1, \dots, C_n \in \mathcal{C}$ and $A_1, \dots, A_n \in \text{Part}(G, S) \cup \text{Part}(H, S)$. Without

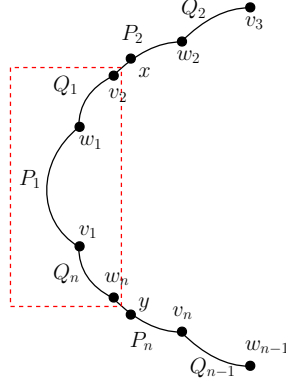

■ **Figure 3** Finding a chordless cycle in Proposition 20.

loss of generality, we may assume that $A_1 \in \text{Part}(G, S)$. For convenience, let $C_{n+1} := C_1$ and $A_{n+1} := A_1$. For each $1 \leq i \leq n$, let P_i be the shortest path from C_i to C_{i+1} in A_i , and let v_i, w_i be the end vertices of P_i where $v_i \in V(C_i)$ and $w_i \in V(C_{i+1})$. Let Q_i be the shortest path from w_i to v_{i+1} in C_{i+1} . We divide cases depending on whether $n = 2$ or not.

Suppose $n = 2$. We choose $C_1, C_2, P_1, P_2, Q_1, Q_2$ such that the cycle C passes the minimum number of connected components of $G[S]$. This minimality implies that C_1 and C_2 are the only connected components of $G[S]$ that contain vertices of both P_1 and P_2 , and there are no edges between the internal vertices of P_1 and the internal vertices of P_2 . Therefore, $P_1 \cup P_2 \cup C_1 \cup C_2$ contains a chordless cycle, as required.

Now, assume that $n \geq 3$. In this case, $v_1 P_1 - Q_1 - P_2 - Q_2 - \dots - P_n - Q_n v_1$ is a cycle in $(G, S) \oplus (H, S)$, but is not necessarily a chordless cycle. Call this cycle C . We claim that C contains a chordless cycle.

Let x be the next vertex of v_2 in P_2 , and let y be the previous vertex of w_n in P_n . See Fig. 3 for an illustration. Take a shortest path P from x to y in the path $y - Q_n - P_1 - Q_1 - x$. Clearly P has length at least 2, as x and y are contained in distinct connected components of Q . Also, every internal vertex of P has no neighbors in the other path of the cycle $v_1 P_1 - Q_1 - P_2 - Q_2 - \dots - P_n - Q_n v_1$ between x and y . So, if we take a shortest path P' from x to y along the other part of the cycle $v_1 P_1 - Q_1 - P_2 - Q_2 - \dots - P_n - Q_n v_1$, then $P \cup P'$ is a chordless cycle. This proves the claim.

(3 \Rightarrow 2). Suppose, towards a contradiction, that $(G, S) \oplus (H, S)$ contains a chordless cycle C . Since (G, S) and (H, S) are chordal, C should contain a vertex of $G - S$ and a vertex of $H - S$. By assumption, we know that every S -block of $(G, S) \oplus (H, S)$ is chordal. Thus, C can contain at most one vertex from each S -block of $(G, S) \oplus (H, S)$. Furthermore, we can observe that $|V(C) \cap V(F)| \leq 1$ for every connected component F of $G[S]$. Otherwise, one of S -blocks of $(G, S) \oplus (H, S)$ should contain all vertices of C , contradicting the fact that every S -block is chordal.

Let $C_1 - C_2 - \dots - C_n - C_1$ be the sequence of connected components of $G[S]$ such that

1. for each $v \in V(C) \cap V(C_i)$, one neighbor of v in C is contained in $G - S$ and the other is contained in $H - S$, and
2. C passes through the connected components of $G[S]$ in this order.

As C contains at least one vertex of $G - S$ and one vertex of $H - S$, such a sequence exists, and $n \geq 2$. Without loss of generality, we may assume that the internal vertices in the path

from C_1 to C_2 (corresponding to the first part of the sequence) are contained in G . Then, the internal vertices in the path from C_2 to C_3 are contained in H , and we use parts of $G - S$ and $H - S$ alternately. For each i , pick $A_i \in \text{Part}(G, S) \cup \text{Part}(H, S)$ corresponding to a connected component of G or S containing the internal vertices of the path from C_i to C_{i+1} . Then $C_1 - A_1 - C_2 - A_2 - \dots - C_n - A_n - C_1$ is a cycle of $\text{Inc}(\mathcal{C}, \text{Part}(G, S) \cup \text{Part}(H, S))$.

(2 \Rightarrow 1). Let $L := L_G \oplus L_H$. Suppose there exists a block B of $(G, S) \oplus (H, S)$ where $L|_{V(B)}$ is not a d -labeling of B . Note that every block of $(G, S) \oplus (H, S)$ contained in either G or H is a d -labeled \mathcal{P} -block. Also, since $(G, S) \oplus (H, S)$ respects (g, h) , every S -block of $(G, S) \oplus (H, S)$ is a d -labeled \mathcal{P} -block. Therefore, B is not an S -block, and it contains at least one vertex of $G - S$ and one vertex of $H - S$. We choose a triple (v, w, D) such that

- $v \in V(B) \cap V(G - S)$, $w \in V(B) \cap V(H - S)$, and D is a cycle containing v and w in B ; and
- the length of D is minimum.

Let P_1 and P_2 be the two paths from v to w in D .

We claim that there are no edges between the internal vertices of P_1 and the internal vertices of P_2 . Suppose there is an edge $p_1 p_2$ for some $p_1 \in V(P_1) \setminus \{v, w\}$ and $p_2 \in V(P_2) \setminus \{v, w\}$. Clearly, either both p_1 and p_2 are contained in G , or both are contained in H . In any case, one of p_1 and p_2 should be contained in $G - S$ or $H - S$, as B can contain at most one vertex of each connected component of $G[S]$. Now, if p_1 and p_2 are contained in G , then we can replace v with one of p_1 and p_2 that is in $G - S$, and obtain a cycle shorter than D ; a contradiction. Similarly, if they are contained in H , then we obtain a cycle shorter than D . This implies that there are no edges between the internal vertices of P_1 and the internal vertices of P_2 . Since $vw \notin E(G)$, D contains a chordless cycle, which contradicts the fact that $(G, S) \oplus (H, S)$ is chordal. We conclude that $(G, S) \oplus (H, S)$ is a block d -labeled \mathcal{P} -block graph. \blacktriangleleft

We also need the following lemma.

► **Lemma 21.** *Let \mathcal{P} be a class of graphs that is block-hereditary and consists of only chordal graphs, and d be a positive integer. Let (G, S) and (H, S) be two compatible block d -labeled \mathcal{P} -block graphs such that $\text{Inc}(\mathcal{C}, \text{Part}(G, S) \cup \text{Part}(H, S))$ has no cycles where \mathcal{C} is the set of connected components of $G[S]$. If F is an S -block of $(G, S) \oplus (H, S)$ and \mathcal{C}_F is the set of connected components of $(F \cap G)[S]$, then $\text{Inc}(\mathcal{C}_F, \text{Part}(F \cap G, S \cap V(F)) \cup \text{Part}(F \cap H, S \cap V(F)))$ has no cycles.*

Proof. Let $S_F := S \cap V(F)$. Suppose towards a contradiction that $\text{Inc}(\mathcal{C}_F, \text{Part}(F \cap G, S_F) \cup \text{Part}(F \cap H, S_F))$ has a cycle. Since $\text{Inc}(\mathcal{C}, \text{Part}(G, S) \cup \text{Part}(H, S))$ has no cycles, G or H has a connected component D with a sequence $C_1 - F_1 - \dots - C_m - F_m - C_1$ such that

- C_1, \dots, C_m are connected components of $G[S]$ that are contained in D ,
- each F_i is a connected component of $G \cap F$ or $H \cap F$ depending on whether D is a connected component of G or H , and
- for each $i \in \{1, \dots, m\}$, $V(C_i \cap F_i)$ and $V(C_i \cap F_{i-1})$ are non-empty.

But then the path from $V(C_1 \cap F_1)$ to $V(C_1 \cap F_m)$ in C_1 should be contained in F , which is a contradiction. We conclude that $\text{Inc}(\mathcal{C}_F, \text{Part}(F \cap G, S_F) \cup \text{Part}(F \cap H, S_F))$ has no cycles. \blacktriangleleft

We prove the main combinatorial result.

Proof of Theorem 18. Suppose $(G_1, S) \oplus (H, S)$ is a block d -labeled \mathcal{P} -block graph that respects (g, h) . Since $\text{Inc}(\mathcal{C}, \text{Part}(G_2, S) \cup \text{Part}(H, S))$ has no cycles, if $(G_2, S) \oplus (H, S)$ respects (g, h) , then by Proposition 20, $(G_2, S) \oplus (H, S)$ is a block d -labeled \mathcal{P} -block graph. Therefore, it is sufficient to show $(G_2, S) \oplus (H, S)$ respects (g, h) .

Choose a pair $(v, B) \in \text{Pair}(G_2, S)$. Let $Q := g(v, B)$, and let F be the S -block of $(G_2, S) \oplus (H, S)$ containing B . As a shortcut, set $S_F := V(F) \cap S$. Let L_F be the function from $V(F)$ to $[d]$ which sends each vertex to its label given from G_2 or H . This is well defined, as G_2 and H have the same labels on vertices in S . Let L_Q be the labeling of Q .

We claim that L_F is a block d -labeling of F and F is partially label-isomorphic to Q . We verify the conditions of Proposition 11 by regarding F as the sum of $(F \cap G_2, S_F)$ and $(F \cap H, S_F)$. We additionally show that $L_Q(V(Q)) \subseteq L_F(V(F))$, in order to complete the proof. Using Lemma 19, we confirm that for every pair $(v', B') \in \text{Pair}(G_2, S)$ where $V(B') \subseteq V(F)$, $g(v', B') = Q$.

Claim 1. For every $(v', B') \in \text{Pair}(G_2, S)$ with $V(B') \subseteq V(F)$, $g(v', B') = Q$.

Proof. Note that $\text{Inc}(\mathcal{C}, \text{Part}(G_2, S) \cup \text{Part}(H, S))$ has no cycles. Since (g, h) is a b -characteristic of (G_2, S) , for every $(v_1, B_1), (v_2, B_2) \in \text{Pair}(G_2, S)$ where B_1 and B_2 are contained in the same S -block of G_2 , $g(v_1, B_1) = g(v_2, B_2)$. Also, since $(G_1, S) \oplus (H, S)$ respects (g, h) , for every $(v_1, B_1), (v_2, B_2) \in \text{Pair}(H, S)$ where B_1 and B_2 are contained in the same S -block of H , $g(v_1, B_1) = g(v_2, B_2)$. Thus the claim follows from Lemma 19. ◀

Let \mathcal{C}_F be the set of connected components of $F[S_F]$. Since $\text{Inc}(\mathcal{C}, \text{Part}(G_2, S) \cup \text{Part}(H, S))$ has no cycles, by Lemma 21, $\text{Inc}(\mathcal{C}_F, \text{Part}(F \cap G_2, S_F) \cup \text{Part}(F \cap H, S_F))$ has no cycles. To apply Proposition 11, it remains to show that $(F \cap G_2, S_F)$ and $(F \cap H, S_F)$ are block-wise Q -compatible.

Claim 2. $F \cap G_2$ and $F \cap H$ are block-wise partially label-isomorphic to Q .

Proof. By **Claim 1** and the fact that (g, h) is a b -characteristic of (G_2, S) , $F \cap G_2$ is block-wise partially label-isomorphic to Q . By **Claim 1** and the fact that $(G_1, S) \oplus (H, S)$ respects (g, h) , $F \cap H$ is block-wise partially label-isomorphic to Q . ◀

Claim 3. $F \cap G_2$ and $F \cap H$ are block-wise Q -compatible.

Proof. Choose a pair $(v, B) \in \text{Pair}(F, S_F)$ and let B_1, B_2 be the S -blocks of G_2 and H containing B respectively. Let B'_1 be the S -block of G_1 containing B . Since $(G_1, S) \oplus (H, S)$ respects (g, h) , $N_{G_1}(v) \cap V(B'_1 - S)$ and $N_F(v) \cap V(B_2 - S)$ have disjoint sets of labels. As (G_1, S) and (G_2, S) have the same b -characteristic, $N_{G_1}(v) \cap V(B_1 - S)$ and $N_{G_2}(v) \cap V(B'_1 - S)$ have the same set of labels, and thus $N_{G_2}(v) \cap V(B_1 - S)$ and $N_F(v) \cap V(B_2 - S)$ have disjoint sets of labels. For $\ell_1 \in L_F(N_{G_2}(v) \cap V(B_1 - S))$ and $\ell_2 \in L_F(N_F(v) \cap V(B_2 - S))$, the vertices in Q with labels ℓ_1 and ℓ_2 are not adjacent because there are no edges between $N_{G_2}(v) \cap V(B_1 - S)$ and $N_F(v) \cap V(B_2 - S)$, and $(G_1, S) \oplus (H, S)$ respects (g, h) . ◀

Therefore, by Proposition 11, L_F is a block d -labeling of F and F is partially label-isomorphic to Q . Lastly, we show that F and Q have the same set of labels, which implies that F is label-isomorphic to Q .

Claim 4. $L_Q(V(Q)) \subseteq L_F(V(F))$.

Proof. Suppose there is a vertex v in Q such that F has no vertex with the label $L_Q(v)$. We choose such a vertex v so that there exists $w \in V(Q)$ that is adjacent to v in Q where the label of w appears in F . We can choose such vertices v and w because Q is connected, $V(F) \neq \emptyset$, and $L_F(V(F)) \subseteq L_Q(V(Q))$. Let w' be a vertex in F with label $L_Q(w)$. Suppose $w' \in V(F - S)$ or there is a connected component of $G[S]$ consisting of w' . Then there is an S -block B of G or H containing w' , and $B[N_B[w']]$ should be label-isomorphic to $Q[N_Q[w]]$. So we may assume that w' is contained in S , and there is a non-trivial block B' of $(F \cap G)[S]$ containing w' .

Again, we observe that the S -block of $(G_1, S) \oplus (H, S)$ containing B' is label-isomorphic to Q . We can also observe that every label appearing in the neighborhood of w' in the S -block of $(G_1, S) \oplus (H, S)$ containing B' appears in the neighborhood of w' in $(G_2, S) \oplus (H, S)$ as well, because (G_1, S) and (G_2, S) have the same b -characteristic. This concludes the proof of the claim. ◀

We conclude that F is label-isomorphic to Q . Since (v, B) was arbitrary chosen, it implies that $(G_2, S) \oplus (H, S)$ respects (g, h) . ◀

5.3 Main algorithm

We use the following observation:

► **Lemma 22.** *Let S be a set and $\mathcal{X}_1, \mathcal{X}_2, \mathcal{Y}$ be sets of subsets of S such that \mathcal{X}_2 is a coarsening of \mathcal{X}_1 , and $\text{Inc}(S, \mathcal{X}_2 \cup \mathcal{Y})$ has no cycles. Then $\text{Inc}(S, \mathcal{X}_1 \cup \mathcal{Y})$ has no cycles.*

Proof. Since we can obtain \mathcal{X}_2 from \mathcal{X}_1 by a sequence of merging two parts into one part, it is sufficient to prove when exactly one set of \mathcal{X}_2 is the union of two sets in \mathcal{X}_1 , and other sets of \mathcal{X}_1 are contained in \mathcal{X}_2 . Suppose $\text{Inc}(S, \mathcal{X}_1 \cup \mathcal{Y})$ has a cycle $c_1 d_1 c_2 d_2 \cdots c_m d_m c_1$ where $\{c_1, \dots, c_m\} \subseteq S$, and let $B \in \mathcal{X}_2$, $B_1, B_2 \in \mathcal{X}_1$ where $B = B_1 \cup B_2$. Clearly, $\{d_1, \dots, d_m\}$ contains both vertices B_1 and B_2 in $\text{Inc}(S, \mathcal{X}_1 \cup \mathcal{Y})$, otherwise, we can obtain the same cycle in $\text{Inc}(S, \mathcal{X}_2 \cup \mathcal{Y})$ by replacing B_i with B . Thus, there is a path from the elements of B_1 to the elements of B_2 in $\text{Inc}(S, \mathcal{X}_1 \cup \mathcal{Y}) - \{B_1, B_2\}$, and it creates a cycle with B in $\text{Inc}(S, \mathcal{X}_2 \cup \mathcal{Y})$; a contradiction. ◀

Proof of Theorem 1. Using Theorem 6 and Lemma 7, we obtain a nice tree decomposition of G of width at most $5w + 4$ in time $\mathcal{O}(c^w \cdot n)$ for some constant c . Let $(T, \mathcal{B} = \{B_t\}_{t \in V(T)})$ be the resulting nice tree decomposition and let r be its root node. For each node t of T , let G_t be the subgraph of G induced by the union of all bags $B_{t'}$ where t' is a descendant of t . Let \mathcal{U}_d be the class of all biconnected d -labeled \mathcal{P} -block graphs, where each H in \mathcal{U}_d has a labeling L_H . Note that $|\mathcal{U}_d| \leq 2^{\binom{d}{2}}$. We define the following notation for every pair of a node t of T and $X \subseteq B_t$:

1. Let $\text{Comp}(t, X)$ be the set of all connected components of $G[B_t \setminus X]$.
2. Let $\text{Part}(t, X)$ be the set of all partitions of $\text{Comp}(t, X)$.
3. Let $\text{Block}(t, X)$ be the set of all non-trivial blocks of $G[B_t \setminus X]$.
4. Let $\text{Pair}(t, X)$ be the set of all pairs (v, B) where $B \in \text{Block}(t, X)$ and $v \in V(B)$.

For each node t of T , $X \subseteq B_t$, and a function $L : B_t \setminus X \rightarrow [d]$, we define $\mathcal{F}(t, X, L)$ as the set of all pairs (g, h) consisting of a function $g : \text{Pair}(t, X) \rightarrow \mathcal{U}_d$ and a function $h : \text{Part}(t, X) \rightarrow 2^{[d]}$, and for an integer i with $0 \leq i \leq k$, and $(g, h) \in \mathcal{F}(t, X, L)$, let $c[t, X, L, i, (g, h)]$ be the family of all partitions \mathcal{X} in $\text{Part}(t, X)$ satisfying the following property: there exist $S \subseteq V(G_t) \setminus B_t$ with $|S| = i$ and a block d -labeling L' of $G_t - (X \cup S)$ where

- $G_t - (X \cup S)$ is a \mathcal{P} -block graph,
- (g, h) is a b -characteristic of $(G_t - (X \cup S), B_t \setminus X)$, and
- $L = L'|_{B_t \setminus X}$ and $\mathcal{X} = \text{Part}(G_t - (X \cup S), B_t \setminus X)$.

Such a pair (S, L') is called a *partial solution* with respect to $c[t, X, L, i, (g, h)]$ and \mathcal{X} .

The main idea is that instead of fully computing $c[t, X, L, i, (g, h)]$, we recursively enumerate a representative set $r[t, X, L, i, (g, h)]$ in $c[t, X, L, i, (g, h)]$. Indeed, the set $r[t, X, L, i, (g, h)]$ represents the partial solutions represented by partitions of $c[t, X, L, i, (g, h)]$. To see this, suppose $\mathcal{X} \in c[t, X, L, i, (g, h)]$ and

- there exists a partial solution (S, L') with respect to \mathcal{X} and $c[t, X, L, i, (g, h)]$, and
- there exists $S_{out} \subseteq V(G) \setminus V(G_t)$ where $G - (S \cup X \cup S_{out})$ is a block d -labeled \mathcal{P} -block graph respecting (g, h) .

The graph $G - (S \cup X \cup S_{out})$ can be seen as the sum of $(G_t - (X \cup S), B_t \setminus X)$ and $(G - (V(G_t) \setminus B_t) - (X \cup S_{out}), B_t \setminus X)$. Let $\mathcal{Z} := \text{Part}(G - (V(G_t) \setminus B_t) - (X \cup S_{out}), B_t \setminus X)$. Since $G - (S \cup X \cup S_{out})$ respects (g, h) , $\text{Inc}(\text{Comp}(t, X), \mathcal{X} \cup \mathcal{Z})$ has no cycles by Proposition 20. As $r[t, X, L, i, (g, h)]$ is a representative set of $c[t, X, L, i, (g, h)]$, there exists $\mathcal{Y} \in r[t, X, L, i, (g, h)]$ where $\text{Inc}(\text{Comp}(t, X), \mathcal{Y} \cup \mathcal{Z})$ has no cycles. By Theorem 18, a partial solution (S', L') with respect to \mathcal{Y} satisfies the property that $G - (S' \cup X \cup S_{out})$ is a \mathcal{P} -block graph respecting (g, h) . Thus, we can store \mathcal{Y} instead of \mathcal{X} .

Whenever we update $r[t, X, L, i, (g, h)]$, we confirm that

- $|r[t, X, L, i, (g, h)]| \leq w \cdot 2^{w-1}$.

We describe how to update families $r[t, X, L, i, (g, h)]$ depending on the type of node t , and prove the correctness of each procedure. We fix such a tuple. For each leaf node t , we assign $r[t, \emptyset, L, i, (g, h)] := \emptyset$ where L, g , and h are empty functions. We may assume that t is not a leaf node.

1) t is an introduce node with child t' :

Let v be the vertex in $B_t \setminus B_{t'}$. If $v \in X$, then $G_t - X = G_{t'} - (X \setminus \{v\})$ and $B_t \setminus X = B_{t'} \setminus (X \setminus \{v\})$. So, we can set $r[t, X, L, i, (g, h)] := r[t', X \setminus \{v\}, L, i, (g, h)]$. We assume that $v \notin X$. Let $L_{res} := L|_{B_{t'} \setminus X}$.

A pair $(g, h) \in \mathcal{F}(t, X, L)$ is called *valid* if it satisfies that

- for every $(v_1, B), (v_2, B) \in \text{Pair}(t, X)$, we have $g(v_1, B) = g(v_2, B)$,
- for every $(w, B) \in \text{Pair}(t, X)$, B is partially label-isomorphic to $g(w, B)$,
- for every $(v, B) \in \text{Pair}(t, X)$, $h(v, B) = \emptyset$, and
- for every $(v, B) \in \text{Pair}(t, X)$ and a neighbor w of v in B and $\ell \in h(w, B)$, $L(v) \notin h(w, B)$ and the vertices in $g(v, B)$ with labels $L(v)$ and ℓ are not adjacent.

A pair $(g', h') \in \mathcal{F}(t', X, L_{res})$ is called a *restriction* of (g, h) if for every $(w_1, B_1) \in \text{Pair}(t', X)$ and $(w_2, B_2) \in \text{Pair}(t, X)$ with $V(B_1) \subseteq V(B_2)$, $g'(w_1, B_1) = g(w_2, B_2)$ and $h'(w_1, B_1) = h(w_2, B_2)$.

We prove the following for the original set $c[t, X, L, i, (g, h)]$.

Claim 1. Let (g, h) be a valid pair. For every $\mathcal{X} \in \text{Part}(t, X)$, $\mathcal{X} \in c[t, X, L, i, (g, h)]$ if and only if there exist a restriction (g', h') of (g, h) and $\mathcal{Y} \in c[t', X, L_{res}, i, (g', h')]$ such that

- v has neighbors on at most one connected component in each part of \mathcal{Y} , and

- if v has at least one neighbor in $G[B_t \setminus X]$, then \mathcal{X} is the partition obtained from \mathcal{Y} by unifying all parts of \mathcal{Y} containing connected components having neighbors of v into one part, and replacing such connected components with the connected component of $G[B_t \setminus X]$ containing v ; and otherwise, $\mathcal{X} = \mathcal{Y} \cup \{\{v\}\}$.

Proof. Suppose $\mathcal{X} \in c[t, X, L, i, (g, h)]$. This means there exists a partial solution (S, L_t) with respect to $c[t, X, L, i, (g, h)]$ and \mathcal{X} . Let $\mathcal{Y} := \text{Part}(G_{t'} - (X \cup S), B_{t'} \setminus X)$. If v has neighbors on two distinct components in one part of \mathcal{Y} , then we obtain a chordless cycle, and this does not happen as $G_t - (X \cup S)$ is chordal. Since we can naturally obtain a restriction (g', h') for $(G_{t'} - (X \cup S), B_{t'} \setminus X)$, we conclude the forward direction of the claim.

For the converse, suppose there exist (g', h') and \mathcal{Y} satisfying the assumption. By the assumption, there exists a partial solution $(S, L_{t'})$ with respect to $c[t', X, L_{res}, i, (g', h')]$ and \mathcal{Y} . Let $H := G_t - (X \cup S)$, $H' := G_{t'} - (X \cup S)$, and $\mathcal{Z} := \text{Part}(G[B_t \setminus X], B_{t'} \setminus X)$. Let L_t be the function from $V(H)$ to $[d]$ obtained from $L_{t'}$ by further assigning $L_t(v) := L(v)$. Observe that $\text{Inc}(\text{Comp}(t', X), \mathcal{Y} \cup \mathcal{Z})$ has no cycles because v has neighbors on at most one connected component in each part of \mathcal{Y} .

We claim that (g, h) is a b -characteristic of $(H, B_t \setminus X)$.

1. (g satisfies the coincidence condition.)

Let $(v_1, B_1), (v_2, B_2) \in \text{Pair}(H, B_t \setminus X)$ such that B_1 and B_2 are contained in a $(B_t \setminus X)$ -block of $(H, B_t \setminus X)$. As (g, h) is valid, we may assume $B_1 \neq B_2$. Note that $B_1 - v$ and $B_2 - v$ are contained in connected components in the same part of \mathcal{Y} . Also, if $|V(B_i)| = 2$ and $v \in V(B_i)$, then B_i cannot be contained in the same $(B_t \setminus X)$ -block of $(H, B_t \setminus X)$ with B_{3-i} . For $i \in \{1, 2\}$, we may assume that $|V(B_i)| \geq 3$ if it contains v . Let $B'_i := B_i$ if $v \notin V(B_i)$, and otherwise, we choose a non-trivial block B'_i of $G[B_{t'} \setminus X]$ contained in B_i . Let $v'_i \in V(B'_i)$. It is sufficient to show that $g'(v'_1, B'_1) = g'(v'_2, B'_2)$ as $g(v_1, B_1) = g'(v'_1, B'_1)$ and $g(v_2, B_2) = g'(v'_2, B'_2)$.

For two pairs $(w_1, D_1), (w_2, D_2) \in \text{Pair}(t', X)$, if D_1 and D_2 are contained in the same $(B_{t'} \setminus X)$ -block of $(H', B_{t'} \setminus X)$ or $(G_t[B_t \setminus X], B_{t'} \setminus X)$, then $g'(w_1, D_1) = g'(w_2, D_2)$ because (g', h') is a b -characteristic of $(H', B_{t'} \setminus X)$ and (g', h') is a restriction of (g, h) . By Lemma 19, we have $g'(v'_1, B'_1) = g'(v'_2, B'_2)$.

2. (h satisfies the neighborhood condition.)

Let $(w, B) \in \text{Pair}(H, B_t \setminus X)$ and F be the $(B_t \setminus X)$ -block of $(H, B_t \setminus X)$ containing B . If $w = v$, then $N_F(v) \setminus (B_t \setminus X) = \emptyset$ and since (g, h) is a valid pair, we have $h(v, B) = \emptyset = L_t(N_F(v) \setminus (B_t \setminus X))$. If B does not contain v , then this is also true. We may assume that $v \neq w$, B contains v , and $|V(B)| \geq 3$. Choose a pair $(w, B') \in \text{Pair}(H', B_{t'} \setminus X)$ where $V(B') \subseteq V(B)$, and let F' be the $(B_{t'} \setminus X)$ -block of $(H', B_{t'} \setminus X)$ containing B' . Note that $N_F(w) \setminus (B_t \setminus X) = N_{F'}(w) \setminus (B_{t'} \setminus X)$. Thus, we have $h(w, B) = h'(w, B') = L_t(N_F(w) \setminus (B_t \setminus X))$.

3. (For every $(w, B) \in \text{Pair}(H, B_t \setminus X)$ and the $(B_t \setminus X)$ -block F of H containing B , F is partially label-isomorphic to $g(w, B)$.)

Let $F_1 := F \cap H'$, $F_2 := F \cap G[B_t \setminus X]$, and \mathcal{C}_F be the set of all connected components of $F_1[V(F_1 \cap F_2)]$. We consider F as the sum of $(F_1, V(F_1 \cap F_2))$ and $(F_2, V(F_1 \cap F_2))$. Since $\text{Inc}(\text{Comp}(t', X), \mathcal{Y} \cup \mathcal{Z})$ has no cycles, by Lemma 21, $\text{Inc}(\mathcal{C}_F, \text{Part}(F_1, V(F_1 \cap F_2)) \cup \text{Part}(F_2, V(F_1 \cap F_2)))$ has no cycles.

Since (g', h') is a b -characteristic of $(F', B_{t'} \setminus X)$ and (g, h) is a valid pair, $(F_1, V(F_1 \cap F_2))$ and $(F_2, V(F_1 \cap F_2))$ are block-wise partially label-isomorphic to $g(w, B)$. Furthermore, as (g, h) is valid, $(F_1, V(F_1 \cap F_2))$ and $(F_2, V(F_1 \cap F_2))$ are block-wise Q -compatible. By Proposition 11, F is partially label-isomorphic to $g(w, B)$.

4. (g satisfies the complete condition.)

This follows from the fact that (g', h') is a restriction of (g, h) and it is a b -characteristic of $(H', B_{t'} \setminus X)$.

All together we can conclude that $\mathcal{X} \in c[t, X, L, i, (g, h)]$. ◀

When $v \notin X$, we update $r[t, X, L, i, (g, h)]$ as follows. We will construct a set \mathcal{K} , and then obtain $r[t, X, L, i, (g, h)]$ by taking a representative set from \mathcal{K} . Set $\mathcal{K} := \emptyset$. We can check whether (g, h) is valid or not in time $\mathcal{O}(wd^2)$. If it is not valid, then we assign $r[t, X, L, i, (g, h)] := \emptyset$. If (g, h) is valid, then for every $(g', h') \in \mathcal{F}(t', X, L_{res})$, we test whether (g', h') is a restriction of (g, h) . Assume that (g', h') is a restriction of (g, h) , otherwise, we skip it. Now, for each $\mathcal{Y} \in r[t', X, L_{res}, i, (g', h')]$, we check the two conditions for (g', h') and \mathcal{Y} in **Claim 1**, and if it is satisfied, then we add the set \mathcal{X} described in **Claim 1** to \mathcal{K} ; otherwise, we skip it. Since $|\mathcal{F}(t, X, L)| \leq 2^{\mathcal{O}(wd^2)}$ and $|r[t', X, L_{res}, i, (g', h')]| \leq w \cdot 2^{w-1}$, the whole procedure can be done in time $2^{\mathcal{O}(wd^2)}$. After we do this for all possible candidates, we take a representative set of \mathcal{K} using Proposition 17, and assign the resulting set to $r[t, X, L, i, (g, h)]$. Since $|\mathcal{K}| \leq 2^{\mathcal{O}(wd^2)}$, by Proposition 17, the procedure of taking a representative set can be done in time $2^{\mathcal{O}(wd^2)}$. Also, we have $|r[t, X, L, i, (g, h)]| \leq w \cdot 2^{w-1}$.

We claim that $r[t, X, L, i, (g, h)]$ is a representative set of $c[t, X, L, i, (g, h)]$. Let $\mathcal{X} \in c[t, X, L, i, (g, h)]$ and $\mathcal{Z} \in \text{Part}(t, X)$ where $\text{Inc}(\text{Comp}(t, X), \mathcal{X} \cup \mathcal{Z})$ has no cycles. By **Claim 1**, there exist a restriction (g', h') of (g, h) and $\mathcal{Y} \in c[t', X, L_{res}, i, (g', h')]$ satisfying the two conditions of **Claim 1**. Let U be the connected component of $B_t \setminus X$ containing v , and let \mathcal{Z}_1 be the partition of $B_{t'} \setminus X$ such that \mathcal{Z}_1 is obtained from \mathcal{Z} by replacing U with the connected components of $B_{t'} \setminus X$ contained in U . Since v has neighbors in at most one connected component in each part of \mathcal{Y} , we can observe that $\text{Inc}(\text{Comp}(t', X), \mathcal{Y} \cup \mathcal{Z}_1)$ has no cycles. So, there exists $\mathcal{Y}_1 \in r[t', X, L_{res}, i, (g', h')]$ where $\text{Inc}(\text{Comp}(t', X), \mathcal{Y}_1 \cup \mathcal{Z}_1)$ has no cycles.

We observe that v has neighbors in at most one connected component of each part of \mathcal{Y}_1 because all connected components of $G[B_{t'} \setminus X]$ having a neighbor of v are still in the same part of \mathcal{Z}_1 . Thus, the partition \mathcal{X}_1 , that is obtained from \mathcal{Y}_1 in **Claim 1**, is added to the set \mathcal{K} . Note that $\text{Inc}(\text{Comp}(t, X), \mathcal{X}_1 \cup \mathcal{Z})$ has no cycles. Therefore, there exists $\mathcal{X}_2 \in r[t, X, L, i, (g, h)]$ such that $\text{Inc}(\text{Comp}(t, X), \mathcal{X}_2 \cup \mathcal{Z})$ has no cycles, as required.

2) t is a forget node with child t' :

Let v be the vertex in $B_{t'} \setminus B_t$. For an extension L' of L on $B_{t'} \setminus X$, a pair $(g', h') \in \mathcal{F}(t', X, L')$ is called an *extension* of (g, h) with respect to L' if

1. for every $(w_1, B_1) \in \text{Pair}(t, X)$ and $(w_2, B_2) \in \text{Pair}(t', X)$ with $V(B_1) \subseteq V(B_2)$, we have $g'(w_2, B_2) = g(w_1, B_1)$,
2. for every $(w, B_1) \in \text{Pair}(t, X)$ and $(v, B_2) \in \text{Pair}(t', X)$ where w is a neighbor v and $V(B_1) \subseteq V(B_2)$, $h'(w, B_2) = h(w, B_1) \setminus \{L'(v)\}$, and
3. for every $(w, B_1) \in \text{Pair}(t, X)$ and $(w, B_2) \in \text{Pair}(t', X)$ where $V(B_1) \subseteq V(B_2)$ and either $v \notin V(B_2)$ or $vw \notin E(G)$, we have $h'(w, B_2) = h(w, B_1)$.

We show the following:

Claim 2. For every $\mathcal{X} \in \text{Part}(t, X)$, $\mathcal{X} \in c[t, X, L, i, (g, h)]$ if and only if one of the following holds:

1. $\mathcal{X} \in c[t', X \cup \{v\}, L, i - 1, (g, h)]$.

2. There exist an extension L_{ext} of L on $B_{t'} \setminus X$ and an extension (g', h') of (g, h) in $\mathcal{F}(t', X, L_{ext})$ with respect to L_{ext} and $\mathcal{Y} \in c[t', X, L_{ext}, i, (g', h')]$ such that \mathcal{X} is the partition obtained from \mathcal{Y} by replacing the connected component U of $B_t \setminus X$ containing v with the connected components of $B_{t'} \setminus X$ contained in U .

Proof. We show the backwards direction. If $\mathcal{X} \in c[t', X \cup \{v\}, L, i - 1, (g, h)]$, then $\mathcal{X} \in c[t, X, L, i, (g, h)]$, as we can put v into the corresponding deletion set. Suppose the statement 2 holds. So, there exists a partial solution $(S, L_{t'})$ with respect to $c[t', X, L_{ext}, i, (g', h')]$ and \mathcal{Y} . As (g', h') is an extension of (g, h) , we can verify that $(G_t - (X \cup S), B_t \setminus X)$ is a block d -labeled graph having (g, h) as a b -characteristic. Thus, $\mathcal{X} \in c[t, X, L, i, (g, h)]$.

For the other direction, suppose that $\mathcal{X} \in c[t, X, L, i, (g, h)]$. So there exists a partial solution (S, L_t) with respect to $c[t, X, L, i, (g, h)]$ and \mathcal{X} . If $v \in S$, then $\mathcal{X} \in c[t', X \cup \{v\}, L, i - 1, (g, h)]$. This corresponds to the first case. We may assume that $v \notin S$. Let $L_{ext} := L_t|_{B_{t'} \setminus X}$ and $\mathcal{Y} := \text{Part}(G_t - (X \cup S), B_{t'} \setminus X)$. Since $G_t - (X \cup S) = G_{t'} - (X \cup S)$, one can observe that \mathcal{X} is the partition obtained from \mathcal{Y} by replacing the connected component U of $B_t \setminus X$ containing v with the connected components of $B_{t'} \setminus X$ contained in U . We focus on showing that there exists an extension (g', h') of (g, h) in $\mathcal{F}(t', X, L_{ext})$ where (g', h') is a b -characteristic of $(G_{t'} - (X \cup S), B_{t'} \setminus X)$.

For each $(v, B) \in \text{Part}(t', X)$,

- if there exists a pair $(w, B') \in \text{Pair}(t, X)$ where B and B' are contained in the same block of $G_t - (X \cup S)$, then we let $g'(v, B) = g(w, B')$, (this is well-defined because (S, L_t) is a partial solution with respect to $c[t, X, L, i, (g, h)]$ and \mathcal{X}),
- otherwise, we know that the block of $G_{t'} - (X \cup S)$ containing v is label-isomorphic to a graph in \mathcal{U}_d ; let $g'(v, B)$ be this graph.

For $(w, B) \in \text{Pair}(t', X)$ where B does not contain v , let $g'(w, B) = g(w, B)$. Also, for every $(w, B) \in \text{Pair}(t', X)$, let $h'(w, B)$ be the set of labels that appear in the neighbors of w in the block of $G_{t'} - (B_t \cup X)$ containing B . Then (g', h') is an extension of (g, h) , and $\mathcal{Y} \in c[t', X, L_{ext}, i, (g, h)]$. ◀

We update $r[t, X, L, i, (g, h)]$ as follows. Set $\mathcal{K} := \emptyset$. First, we add all partitions in $r[t', X \cup \{v\}, L, i - 1, (g, h)]$ to \mathcal{K} . At the second step, for every possible extension L_{ext} of L by choosing a label for v , and for every $(g', h') \in \mathcal{F}(t', X, L_{ext})$, we test whether (g', h') is an extension of (g, h) . In case when (g', h') is an extension of (g, h) with respect to L_{ext} , for all partitions $\mathcal{Y} \in r[t', X, L, i, (g', h')]$, we add the set \mathcal{X} satisfying the second statement in **Claim 2** to \mathcal{K} , and otherwise, we skip this pair. This can be done in time $2^{\mathcal{O}(wd^2)}$. After we do this for all possible candidates, we take a representative set of \mathcal{K} using Proposition 17, and assign the resulting set to $r[t, X, L, i, (g, h)]$. Notice that $|\mathcal{K}| \leq 2^{\mathcal{O}(wd^2)}$. By Proposition 17, the procedure of obtaining a representative set can be done in time $2^{\mathcal{O}(wd^2)}$, and we have $|r[t, X, L, i, (g, h)]| \leq w \cdot 2^{w-1}$.

We claim that $r[t, X, L, i, (g, h)]$ is a representative set of $c[t, X, L, i, (g, h)]$. Let $\mathcal{X} \in c[t, X, L, i, (g, h)]$ and $\mathcal{Z} \in \text{Part}(t, X)$ where $\text{Inc}(\text{Comp}(t, X), \mathcal{X} \cup \mathcal{Z})$ has no cycles. By **Claim 2**, one of two statements in the claim holds. If $\mathcal{X} \in c[t', X \cup \{v\}, L, i - 1, (g, h)]$, then there exists $\mathcal{X}_1 \in r[t', X \cup \{v\}, L, i - 1, (g, h)]$ where $\text{Inc}(\text{Comp}(t', X), \mathcal{X}_1 \cup \mathcal{Z})$ has no cycles. So, \mathcal{X}_1 is added to \mathcal{K} , and thus, there exists $\mathcal{X}_2 \in r[t, X, L, i, (g, h)]$ such that $\text{Inc}(\text{Comp}(t, X), \mathcal{X}_2 \cup \mathcal{Z})$ has no cycles. Assume that the statement 2 holds. If v has at least one neighbor in $G[B_t \setminus X]$, then let \mathcal{Z}_1 be the partition obtained from \mathcal{Z} by unifying all parts having a connected component containing a neighbor of v and replacing those connected components of $G[B_{t'} \setminus X]$ with the connected component of $G[B_t \setminus X]$ containing

v , and otherwise, let $\mathcal{Z}_1 := \mathcal{Z} \cup \{\{v\}\}$. Observe that $\text{Inc}(\text{Comp}(t', X), \mathcal{Y} \cup \mathcal{Z}_1)$ has no cycles. Thus, there exists $\mathcal{Y}_1 \in r[t', X, L_{ext}, i, (g', h')]$ where $\text{Inc}(\text{Comp}(t', X), \mathcal{Y}_1 \cup \mathcal{Z}_1)$ also has no cycles. In the procedure, the set satisfying the second statement in **Claim 2** to \mathcal{K} , and thus, there exists $\mathcal{X}_2 \in r[t, X, L_{ext}, i, (g', h')]$ where $\text{Inc}(\text{Comp}(t, X), \mathcal{X}_2 \cup \mathcal{Z})$ has no cycles.

3) t is a join node with two children t_1 and t_2 :

We show the following:

Claim 3. For every $\mathcal{X} \in \text{Part}(t, X)$, $\mathcal{X} \in c[t, X, L, i, (g, h)]$ if and only if there exist integers i_1, i_2 with $i_1 + i_2 = i$, $(g, h_1) \in \mathcal{F}(t_1, X, L)$, $(g, h_2) \in \mathcal{F}(t_2, X, L)$, $\mathcal{X}_1 \in c[t_1, X, L, i_1, (g, h_1)]$, and $\mathcal{X}_2 \in c[t_2, X, L, i_2, (g, h_2)]$ such that

- $\text{Inc}(\text{Comp}(t, X), \mathcal{X}_1 \cup \mathcal{X}_2)$ has no cycles,
- $\mathcal{X} = \mathcal{X}_1 \uplus \mathcal{X}_2$, and
- for each $(w, B) \in \text{Pair}(t, X)$, $h_1(w, B) \cap h_2(w, B) = \emptyset$ and $h(w, B) = h_1(w, B) \cup h_2(w, B)$, and for $\ell_1 \in h_1(w, B)$ and $\ell_2 \in h_2(w, B)$, the vertices with labels ℓ_1 and ℓ_2 in $g(w, B)$ are not adjacent.

Proof. The forward direction is straightforward by Proposition 20. Suppose there exist integers i_1, i_2 with $i_1 + i_2 = i$, (g, h_1) , (g, h_2) , and partitions $\mathcal{X}_1, \mathcal{X}_2$ as specified in the claim. For each $j \in \{1, 2\}$, let (S_j, L_j) be a partial solution with respect to $c[t_j, X, L, i_j, (g, h_j)]$ and \mathcal{X}_j . For each $i \in \{1, 2\}$, let $H_i := G_{t_i} - (X \cup S_i)$, and let $H := H_1 \cup H_2$. Let L_H be the function from $V(H)$ to $[d]$ where $L_H(v)$ is given from block d -labelings L_1 and L_2 .

We claim that (g, h) is a b -characteristic of $(F, B_t \setminus X)$. Since $\mathcal{X} = \text{Part}(F, B_t \setminus X)$ it implies that $\mathcal{X} \in c[t, X, L, i, (g, h)]$. We verify the conditions of the definition of b -characteristics.

1. (g satisfies the coincidence condition.)

Since $\text{Inc}(\text{Comp}(t, X), \mathcal{X}_1 \cup \mathcal{X}_2)$ has no cycles and (g, h_i) is a b -characteristic of H_i , it follows from Lemma 19.

2. (h satisfies the neighborhood condition.)

It follows from the assumption that $h(v, B) = h_1(v, B) \cup h_2(v, B)$ for each $(v, B) \in \text{Part}(t, X)$.

3. (For every $(v, B) \in \text{Pair}(H, B_t \setminus X)$ and the $(B_t \setminus X)$ -block F of H containing B , F is partially label-isomorphic to $g(v, B)$.)

We consider F as the sum of $(F \cap H_1, V(F) \cap (B_t \setminus X))$ and $(F \cap H_2, V(F) \cap (B_t \setminus X))$. Let \mathcal{C}_F be the set of connected components of $G[F \cap (B_t \setminus X)]$. By Lemma 21, $\text{Inc}(\mathcal{C}_F, \text{Part}(F \cap H_1, V(F) \cap (B_t \setminus X)) \cup \text{Part}(F \cap H_2, V(F) \cap (B_t \setminus X)))$ has no cycles. Since each (g, h_j) is a b -characteristic of $(H_j, B_{t_j} \setminus X)$, $(F \cap H_1, V(F) \cap (B_t \setminus X))$ and $(F \cap H_2, V(F) \cap (B_t \setminus X))$ are block-wise partially label-isomorphic to $g(v, B)$. Moreover, $(F \cap H_1, V(F) \cap (B_t \setminus X))$ and $(F \cap H_2, V(F) \cap (B_t \setminus X))$ are block-wise $g(v, B)$ -compatible, because of the assumption that for each $(w, B) \in \text{Pair}(t, X)$, $h_1(w, B) \cap h_2(w, B) = \emptyset$ and $h(w, B) = h_1(w, B) \cup h_2(w, B)$, and for $\ell_1 \in h_1(w, B)$ and $\ell_2 \in h_2(w, B)$, the vertices with labels ℓ_1 and ℓ_2 in $g(w, B)$ are not adjacent. By Proposition 11, F is partially label-isomorphic to $g(v, B)$.

4. (g satisfies the complete condition.)

This follows from the fact that (g, h_j) is a b -characteristic of $(H_j, B_t \setminus X)$.

It proves that (g, h) is a b -characteristic of $(H, B_t \setminus X)$. ◀

We update $r[t, X, L, i, (g, h)]$ as follows. Set $\mathcal{K} := \emptyset$. We fix integers i_1, i_2 with $i_1 + i_2 = i$, $(g, h_1) \in \mathcal{F}(t_1, X, L)$ and $(g, h_2) \in \mathcal{F}(t_2, X, L)$. We can check in time $\mathcal{O}(wd^2)$ the condition that

- for each $(w, B) \in \text{Pair}(t, X)$, $h_1(w, B) \cap h_2(w, B) = \emptyset$ and $h(w, B) = h_1(w, B) \cup h_2(w, B)$, and for $\ell_1 \in h_1(w, B)$ and $\ell_2 \in h_2(w, B)$, the vertices with labels ℓ_1 and ℓ_2 in $g(w, B)$ are not adjacent.

If these pairs do not satisfy this condition, then we skip them. We assume that these pairs satisfy this condition. For $\mathcal{X}_1 \in r[t_1, X, L, i_1, (g, h_1)]$ and $\mathcal{X}_2 \in r[t_2, X, L, i_2, (g, h_2)]$, we test whether $\text{Inc}(\text{Comp}(t, X), \mathcal{X}_1 \cup \mathcal{X}_2)$ has no cycles and $\mathcal{X} = \mathcal{X}_1 \uplus \mathcal{X}_2$. We can check it in time $\mathcal{O}(w)$. If they satisfy the two conditions, then we add the partition \mathcal{X} to the set \mathcal{K} , and otherwise, we do not add. After we do this for all possible candidates, we take a representative set of \mathcal{K} using Proposition 17, and assign the resulting set to $r[t, X, L, i, (g, h)]$. The total running time is $k \cdot 2^{\mathcal{O}(wd^2)}$ because $|\mathcal{F}(t_j, X, L)| \leq 2^{\mathcal{O}(wd^2)}$ and $|r[t_j, X, L, i_j, (g, h_j)]| \leq w \cdot 2^{w-1}$ for each $j \in \{1, 2\}$. We have $|r[t, X, L, i, (g, h)]| \leq w \cdot 2^{w-1}$.

We claim that $r[t, X, L, i, (g, h)]$ is a representative set of $c[t, X, L, i, (g, h)]$. Let $\mathcal{X} \in c[t, X, L, i, (g, h)]$ and $\mathcal{Z} \in \text{Part}(t, X)$ where $\text{Inc}(\text{Comp}(t, X), \mathcal{X} \cup \mathcal{Z})$ has no cycles. By **Claim 3**, there exist $(g, h_1) \in \mathcal{F}(t_1, X, L)$, $(g, h_2) \in \mathcal{F}(t_2, X, L)$, $\mathcal{X}_1 \in c[t_1, X, L, i_1, (g, h_1)]$, and $\mathcal{X}_2 \in c[t_2, X, L, i_2, (g, h_2)]$ where $\text{Inc}(\text{Comp}(t, X), \mathcal{X}_1 \cup \mathcal{X}_2)$ has no cycles and $\mathcal{X} = \mathcal{X}_1 \uplus \mathcal{X}_2$. By Lemma 22, each $\text{Inc}(\text{Comp}(t, X), \mathcal{X}_j \cup \mathcal{Z})$ has no cycles. For each $j \in \{1, 2\}$, let $\mathcal{Z}_j := \mathcal{X}_j \uplus \mathcal{Z}$. We observe that each $\text{Inc}(\text{Comp}(t, X), \mathcal{X}_j \cup \mathcal{Z}_{3-j})$ has no cycles, and thus, there exists $\mathcal{X}'_j \in r[t_j, X, L, i_j, (g, h_j)]$ where $\text{Inc}(\text{Comp}(t, X), \mathcal{X}'_j \cup \mathcal{Z}_{3-j})$ has no cycles. Let $\mathcal{X}' := \mathcal{X}'_1 \uplus \mathcal{X}'_2$. By the construction, this set \mathcal{X}' should be added to \mathcal{K} and thus there exists $\mathcal{X}'' \in r[t, X, L, i, (g, h)]$ where $\text{Inc}(\text{Comp}(t, X), \mathcal{X}'' \cup \mathcal{Z})$ has no cycles.

Total running time. We denote $|V(G)|$ by n . Note that the number of nodes in T is $\mathcal{O}(wn)$ by Lemma 7. For fixed $t \in V(T)$, there are at most 2^{w+1} possible choices for $X \subseteq B_t$, and for fixed $X \subseteq B_t$, there are at most d^{w+1} possible functions L . Furthermore, the size of $\mathcal{F}(t, X, L)$ is bounded by $2^{\mathcal{O}(wd^2)}$. Thus, there are $\mathcal{O}(n \cdot k \cdot \max(2, d)^{w+1} \cdot 2^{\mathcal{O}(wd^2)})$ tables.

In summary, the algorithm runs in time $\mathcal{O}(n \cdot k \cdot \max(2, d)^{w+1} \cdot 2^{\mathcal{O}(wd^2)} \cdot k = 2^{\mathcal{O}(wd^2)} k^2 n$. ◀

6 Lower bound for fixed d

We showed that BOUNDED \mathcal{P} -COMPONENT VERTEX DELETION and BOUNDED \mathcal{P} -BLOCK VERTEX DELETION admit single-exponential time algorithms parameterized by treewidth, whenever \mathcal{P} is a class of chordal graphs. We now establish that, assuming the ETH, this is no longer the case when \mathcal{P} contains a graph that is not chordal.

In the $k \times k$ INDEPENDENT SET problem, one is given a graph $G = ([k] \times [k], E)$ over the k^2 vertices of a k -by- k grid. We denote by $\langle i, j \rangle$ with $i, j \in [k]$ the vertex of G in the i -th row and j -th column. The goal is to find an independent set of size k in G that contains exactly one vertex in each row. The PERMUTATION $k \times k$ INDEPENDENT SET problem is similar but with the additional constraint that the independent set should also contain exactly one vertex per column.

► **Theorem 23.** *For any fixed integer $d \geq 4$, if \mathcal{P} contains the cycle graph on $\ell \geq 4$ vertices, then BOUNDED \mathcal{P} -COMPONENT VERTEX DELETION, or BOUNDED \mathcal{P} -BLOCK VERTEX DELETION, is not solvable in time $2^{o(w \log w)} n^{\mathcal{O}(1)}$ on graphs of treewidth at most w even for fixed $d = \ell$, unless the ETH fails.*

Proof. We reduce from PERMUTATION $k \times k$ INDEPENDENT SET which, like PERMUTATION $k \times k$ CLIQUE, cannot be solved in time $2^{o(k \log k)} n^{\mathcal{O}(1)}$ unless the ETH fails [13]. Let $G = ([k] \times [k], E)$ be an instance of PERMUTATION $k \times k$ INDEPENDENT SET. We assume that $\forall h, i, j \in [k]$ with $h \neq i$, $\langle i, j \rangle \langle h, j \rangle \in E$. Adding these edges does not change the YES- and NO-instances, but has the virtue of making PERMUTATION $k \times k$ INDEPENDENT SET equivalent to $k \times k$ INDEPENDENT SET. We also assume that $\forall h, i, j \in [k]$, $\langle i, j \rangle \langle i, h \rangle \notin E$, since at most one of $\langle i, j \rangle$ and $\langle i, h \rangle$ can be in a given solution. Let $m := |E| = \mathcal{O}(k^4)$ be the number of edges of G .

Outline. We build two almost identical graphs $G' = (V', E')$ and $G'' = (V', E'')$ with treewidth at most $(3d+4)k + 4d + 3 = \mathcal{O}(k)$, and $((3d-2)k^2 + 2k)m$ vertices, such that the following three conditions are equivalent:

1. G has an independent set of size k with one vertex per row of G .
2. There is a set $S \subseteq V'$ of size at most $(2d+2)k(k-1)m$ such that each connected component of $G' - S$ has size at most d .
3. There is a set $S \subseteq V'$ of size at most $(2d+2)k(k-1)m$ such that each block of $G'' - S$ has size at most d .

The overall construction of G' and G'' will display m almost copies of the encoding of an *edgeless* G arranged in a cycle. Each copy embeds one distinct edge of G . The point of having the information of G distilled edge by edge in G' and G'' is to control the treewidth. This general idea originates from a paper of Lokshtanov et al. [11].

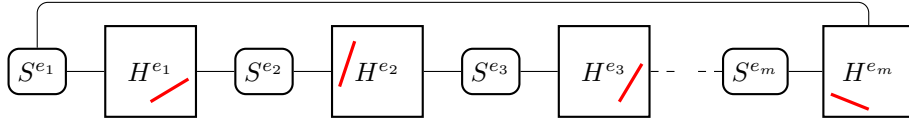

■ **Figure 4** A high-level schematic of G' and G'' . The H^{e_i} s only differ by a constant number of edges (in red/light gray) that encode their edge e_i of G .

Construction. We first describe G' . As a slight abuse of notation, a gadget (and, more generally, a subpart of the construction) may refer to either a subset of vertices or to an induced subgraph. For each $e = \langle i^e, j^e \rangle \langle i'^e, j'^e \rangle \in E$, we detail the internal construction of H^e and S^e of Fig. 4 and how they are linked to one another. Each vertex $v = \langle i, j \rangle$ of G is represented by a gadget $H^e(v)$ on $2d+2$ vertices in G' : two isolated vertices v_-^e and v_+^e , and two disjoint cycles of length d . We add all the edges between $H^e(\langle i, j \rangle)$ and $H^e(\langle i', j' \rangle)$ for $i, j, j' \in [k]$ with $j \neq j'$. We also add all the edges between $H^e(\langle i^e, j^e \rangle)$ and $H^e(\langle i'^e, j'^e \rangle)$. Note that, in general, there is no edge between $H^e(\langle i, j \rangle)$ and $H^e(\langle i', j \rangle)$ for $i, i', j \in [k]$ with $i \neq i'$. We call H^e the graph induced by the union of every $H^e(v)$, for $v \in V(G)$. The *row/column selector* gadget S^e consists of a set S_r^e of k vertices with one vertex r_i^e for each row index $i \in [k]$, and a set S_c^e of k vertices with one vertex c_j^e for each column index $j \in [k]$. The gadget S^e forms an independent set of size $2k$. We arbitrarily label the edges of G : e_1, e_2, \dots, e_m . For each $h \in [m]$ and $v = \langle i, j \rangle \in V$, we link $v_-^{e_h}$ to $r_i^{e_h}$ (the row index of v) and we add a path with $d-3$ edges from $v_-^{e_h}$ to $c_j^{e_h}$ (the column index of v). We also link $v_+^{e_h}$ to $r_i^{e_{h+1}}$ and to $c_j^{e_{h+1}}$ with the convention that $e_{m+1} = e_1$. That concludes the construction (see Fig. 5). To obtain G'' from G' , we add the edges $c_j^{e_h} c_{j+1}^{e_h}$ for every $h \in [m]$ and $j \in [k-1]$. We ask for a deletion set S of size $s := (2d+2)k(k-1)m$.

Treewidth of G' and G'' . We claim that the pathwidth, and hence treewidth, of G' and G'' are bounded by $(3d+4)k + 4d + 3$. For any edge $e \in E$, we set $H(e) :=$

claim that the rest of $G' - S$ is mk disjoint C_d s formed with the vertices $v_{p+}^{e_{h-1}}, v_{p-}^{e_h}, r_p^{e_h}, c_{j_p}^{e_h}$, and the $d - 4$ vertices of the subdivision of $v_{p-}^{e_h} c_{j_p}^{e_h}$, for any $h \in [m]$ and $p \in [k]$ (with the convention that $e_0 = e_m$). Indeed, let us recall that $\{j_1, j_2, \dots, j_k\} = [k]$. Therefore, $(\{v_{p+}^{e_{h-1}}, v_{p-}^{e_h}, r_p^{e_h}, c_{j_p}^{e_h}, \text{the } d - 4 \text{ vertices of the subdivision of } v_{p-}^{e_h} c_{j_p}^{e_h}\})_{h \in [m], p \in [k]}$ is a family of mk pairwise disjoint sets of size d . The vertices $r_p^{e_h}$ and $c_{j_p}^{e_h}$ have degree 2 in $G' - S$ since I contains only one vertex in the p -th row of G , and I contains only one vertex in the j_p -th column; and in both cases this vertex is v_p . The vertices $v_{p+}^{e_{h-1}}$ and $v_{p-}^{e_h}$ also have degree 2 in $G' - S$ as mentioned already. Therefore, $G' - S$ is a disjoint union of C_d s. The implication $1 \Rightarrow 3$ is derived similarly. We now claim that, with the same deletion set S , all the blocks of $G'' - S$ are isomorphic to C_d or K_2 . As \mathcal{P} is a hereditary class that contains the induced cycle of length $d \geq 4$, it holds that $K_2 \in \mathcal{P}$. We still have the property that the C_d s within any $H^e(v_i)$ are isolated in $G'' - S$. Now, the slight difference is that $(\{v_{p+}^{e_{h-1}}, v_{p-}^{e_h}, r_p^{e_h}, c_{j_p}^{e_h}, \text{the } d - 4 \text{ vertices of the subdivision of } v_{p-}^{e_h} c_{j_p}^{e_h}\})_{h \in [m], p \in [k]}$ induces m disjoint $\mathcal{C}_{k,d}$ s in $G'' - S$, where $\mathcal{C}_{k,d}$ is the graph obtained by linking each of the k vertices of a path to the two endpoints of a path on $d - 1$ vertices. Informally, $\mathcal{C}_{k,d}$ corresponds to k C_d s attached to different vertices of a path on k vertices. In this case, the path consists of the vertices $c_1^{e_h}, c_2^{e_h}, \dots, c_k^{e_h}$. Finally, we observe that the blocks of $\mathcal{C}_{k,d}$ are k C_d s and $k - 1$ K_2 s.

We now show that $2 \Rightarrow 1$ and $3 \Rightarrow 1$. We assume that there is a set $S \subseteq V'$ of size at most s such that all the blocks of $G'' - S$ (resp. $G' - S$) have size at most d . We note that this corresponds to assuming 3 (resp. a weaker assumption than 2). The first property we show on S is that, for any $e \in E$ and $i \in [k]$, $|H^e(i) \cap S| \geq (2d + 2)(k - 1)$. In other words, strictly more than $2d + 2$ vertices of $H^e(i)$ cannot remain in $G'' - S$ (or $G' - S$). Assume, for the sake of contradiction, that $H^e(i) - S$ contains at least $2d + 3$ vertices. Observe that $H^e(i) - S$ cannot contain at least one vertex from three distinct $H^e(u)$, $H^e(v)$, and $H^e(w)$ (with u, v and w in the i -th row of G), since then $H^e(i) - S$ would be 2-connected (and of size $> d$). For the same reason, $H^e(i) - S$ cannot contain at least two vertices in $H^e(u)$ and at least two vertices in another $H^e(v)$. Therefore, the only way of fitting $(2d + 3)$ vertices in $H^e(i) - S$ is the $(2d + 2)$ vertices of an $H^e(u)$ plus one vertex from some other $H^e(v)$. But then, this vertex of $H^e(v)$ would form, together with one C_d of $H^e(u)$, a 2-connected subgraph of $G'' - S$ (or $G' - S$) of size $d + 1$. Now, we know that $|H^e(i) \cap S| \geq (2d + 2)(k - 1)$. As there are precisely mk sets $H^e(i)$ in G' (and they are disjoint), it further holds that $|H^e(i) \cap S| = (2d + 2)(k - 1)$, since otherwise S would contain strictly more than $s = (2d + 2)k(k - 1)m$ vertices. Thus, $H^e(i) - S$ contains exactly $2d + 2$ vertices. By the previous remarks, $H^e(i) - S$ can only consist of the $2d + 2$ vertices of the same $H^e(u)$ or $2d + 1$ vertices of $H^e(u)$ plus one vertex from another $H^e(v)$. In fact, the latter case is not possible, since the vertex of $H^e(v)$ would form, with at least one remaining C_d of the $2d + 1$ vertices of $H^e(u)$, a 2-connected subgraph of $G'' - S$ (or $G' - S$) of size $d + 1$. Note that this is why we needed two disjoint C_d s in the construction instead of just one. So far, we have proved that, assuming 2 or 3, for any $e \in E$ and $i \in [k]$, $H^e(i) \cap S = H^e(v_{i,e})$ for some vertex $v_{i,e}$ of the i -th row of G , and for any $e \in E$, $S^e \cap S = \emptyset$.

The second part of the proof consists of showing that $v_{i,e}$ does not depend on e . Formally, we want to show that there is a v_i such that, for any $e \in E$, $v_{i,e} = v_i$. Observe that it is enough to derive that, for any $h \in [m]$, $v_{i,e_h} = v_{i,e_{h+1}}$ (with $e_{m+1} = e_1$). Let $j \in [k]$ (resp. $j' \in [k]$) be the column of v_{i,e_h} (resp. $v_{i,e_{h+1}}$) in G . We first assume 2. For any $h \in [m]$, $v_{i,e_h}^{e_h}, r_i^{e_{h+1}}, v_{i,e_{h+1}-}^{e_{h+1}}, c_{j'}^{e_{h+1}}, c_j^{e_{h+1}}$ plus the $d - 4$ vertices of the subdivision of $v_{i,e_{h+1}-}^{e_{h+1}} c_{j'}^{e_{h+1}}$ induces a path (that is, a connected subgraph) of size $d + 1$ in $G'' - S$, unless $j = j'$ (with $e_{m+1} = e_1$). Therefore, $j = j'$. As v_{i,e_h} and

$v_{i,e_{h+1}}$ have the same column j and the same row i in G , $v_{i,e_h} = v_{i,e_{h+1}}$. Now, we assume 3. For any $h \in [m]$, $v_{i,e_h}^{e_h}, r_i^{e_{h+1}}, v_{i,e_{h+1}-}^{e_{h+1}}, c_{j'}^{e_{h+1}}, c_{j'+1}^{e_{h+1}}, \dots, c_{j-1}^{e_{h+1}}, c_j^{e_{h+1}}$ if $j \geq j'$ (resp. $v_{i,e_h}^{e_h}, r_i^{e_{h+1}}, v_{i,e_{h+1}-}^{e_{h+1}}, c_{j'}^{e_{h+1}}, c_{j'-1}^{e_{h+1}}, \dots, c_{j+1}^{e_{h+1}}, c_j^{e_{h+1}}$ if $j \leq j'$) plus the $d-4$ vertices of the subdivision of $v_{i,e_{h+1}-}^{e_{h+1}} c_{j'}^{e_{h+1}}$ induces a cycle (that is, a 2-connected subgraph) of length at least $d+1$ in $G'' - S$, unless $j = j'$ (with $e_{m+1} = e_1$). Again, $j = j'$; and the vertices v_{i,e_h} and $v_{i,e_{h+1}}$ have the same column and the same row in G , which implies that $v_{i,e_h} = v_{i,e_{h+1}}$. In both cases (2 or 3), we can now safely define $v_i := v_{i,e}$.

We finally claim that $\{v_1, v_2, \dots, v_k\}$ is an independent set in G (and for each $i \in [k]$, v_i is in the i -th row). Indeed, if there were an edge $e = v_i v_j \in E$ for some $i \neq j \in [k]$, then $H^e(v_i) \cup H^e(v_j)$ would induce a 2-connected subgraph of size $2(2d+2) > d$ in $G'' - S$ (or $G' - S$).

That finishes the proof that $1 \Leftrightarrow 2 \Leftrightarrow 3$. Therefore, for any fixed integer $d \geq 4$, an algorithm running in time $2^{o(w \log w)} |V'|^{\mathcal{O}(1)}$ for either BOUNDED \mathcal{P} -COMPONENT VERTEX DELETION or BOUNDED \mathcal{P} -BLOCK VERTEX DELETION on graphs of treewidth w with $C_d \in \mathcal{P}$ would also solve PERMUTATION $k \times k$ INDEPENDENT SET in time

$$2^{o((3d+4)k+4d+3) \log((3d+4)k+4d+3)} (((3d-2)k^2 + 2k)m)^{\mathcal{O}(1)} = 2^{o(k \log k)} n^{\mathcal{O}(1)},$$

which contradicts the ETH. ◀

7 Hardness and lower bounds, when d is not fixed

In this section, we prove Theorem 5. Our first reduction is from the following problem:

MULTICOLORED CLIQUE	Parameter: k
Input: A graph G , a positive integer k , and a partition (V_1, V_2, \dots, V_k) of $V(G)$.	
Question: Is there a k -clique X of G such that $ X \cap V_i = 1$ for each $i \in [k]$?	

We call a set V_i , for some $i \in [k]$, a *color class*. The problem MULTICOLORED CLIQUE is known to be $W[1]$ -complete (see, for example, [5]), and it is clear that this remains true under the assumption that there are no edges between vertices of the same color class. Moreover, we may assume that each color class has the same size, and between every distinct pair of color classes we have the same number of edges [9]. We say that $X \subseteq V(G)$ is a *multicolored k -clique* if X is a k -clique such that $|X \cap V_i| = 1$ for each $i \in [k]$.

► Theorem 24. BOUNDED \mathcal{P} -COMPONENT VERTEX DELETION is $W[1]$ -hard parameterized by the combined parameter (w, k) , when \mathcal{P} contains all chordal graphs.

Before proving this theorem, we describe the reduction used in the proof. Given an instance $(G, k, (V_1, \dots, V_k))$ of MULTICOLORED CLIQUE, where each color class has size t , we construct a graph G' such that G has a multicolored k -clique if and only if there exists a set $S \subseteq V(G')$ of size at most k' such that each connected component of $G' - S$ consists of at most d vertices, where $k' = 3 \binom{k+1}{2} - 6$ and $d = 3t^2 + 3t + 3$, and the treewidth of G' is bounded above by $54k - 69$. We may assume that $k \geq 2$.

Let $V_i = \{v_i^1, v_i^2, \dots, v_i^t\}$, for each $i \in [k]$. For $i, j \in [k]$ with $i < j$, we denote the set of edges in $G[V_i \cup V_j]$ by $E_{i,j}$, and we may assume that $|E_{i,j}| = p$, say. We construct G' from several gadgets; namely, an “edge-encoding gadget” $G_{i,j}$ for each $i, j \in [k]$ with $i < j$, which represents the set $E_{i,j}$, linked together by copies of one of the “propagator gadgets”, H_i or \tilde{H}_i , which collectively represent the color class V_i for some $i \in [k]$. We also have a gadget $G_{i,i}$, for each $i \in [2, k-2]$, which ensures that the vertex selection in the H_i gadgets also propagates to the \tilde{H}_i gadgets.

Each gadget encodes a sequence of integers $X = \langle x_0, x_1, \dots, x_{z+1} \rangle$, where $x_0 \geq 3$, and $x_s - x_{s-1} \geq 3$ for each $s \in [z+1]$. We denote such a gadget $G(X)$ and call it a *gadget of order z* . It is constructed as follows. First, set

$$(d_0, d_1, d_2, \dots, d_z) := (x_0, x_1 - x_0, x_2 - x_1, \dots, x_z - x_{z-1}, x_{z+1} - x_z).$$

Note that $d_q \geq 3$ for every $q \in [0, z]$. For each $q \in [0, z]$, we now define a graph P_q which resembles a “thickened path”. For $q \in [1, z-1]$, let P_q be the graph on the vertex set $\{w_{q,1}, w_{q,2}, \dots, w_{q,d_q-1}\}$ with edges between distinct $w_{q,d}$ and $w_{q,d'}$ if and only if $|d-d'| \in [2]$. For $q \in \{0, z\}$, let P_q be the graph on the vertex set $\{w_{q,1}, w_{q,2}, \dots, w_{q,d_q}\}$ with edges between distinct $w_{q,d}$ and $w_{q,d'}$ if and only if $|d-d'| \in [3]$. For each $q \in [z]$, we add a vertex u_q adjacent to $w_{q-1,1}$, $w_{q-1,2}$, $w_{q,1}$, and $w_{q,2}$. The resulting graph $G(X)$ consists of $(\sum_{q \in [z]} d_q) + 1 = x_{z+1} + 1$ vertices, and, for $q \in [z]$, the graph obtained by deleting u_q has two components: one of size x_q , and the other of size $x_{z+1} - x_q$. Let $B := \{w_{0,1}, w_{0,2}, w_{0,3}\}$ and $D := \{w_{z,1}, w_{z,2}, w_{z,3}\}$. Since we will use several copies of this gadget, we usually refer to P_q as $P_q(G(X))$, a vertex $v \in V(G(X))$ as $v(G(X))$, and B or D as $B(G(X))$ or $D(G(X))$, respectively; but we sometimes omit the “ $(G(X))$ ” when there is no ambiguity.

We now describe the *edge encoding gadget* $G_{i,j}$, for some $i, j \in [k]$ with $i < j$; an example is given in Fig. 6a. We can uniquely describe an edge between a vertex in V_i and a vertex in V_j by an ordered pair (a, b) , representing the edge $v_i^a v_j^b$, where $a, b \in [t]$. We define an injective function ϕ from such a pair to an integer in $\{3, 6, \dots, 3t^2\}$, as given by $(a, b) \mapsto 3t(a-1) + 3b$. Thus, the set $\{\phi(a, b) : v_i^a v_j^b \in E_{i,j}\}$ uniquely describes the set $E_{i,j}$. Let $(f_{i,j}^0, f_{i,j}^1, \dots, f_{i,j}^p)$ be the sequence obtained after ordering the elements of this set in increasing order, and let $f_{i,j}^{p+1} = 3t^2 + 3$. Note that $f_{i,j}^0 \geq 3$, and $f_{i,j}^q - f_{i,j}^{q-1} \geq 3$ for each $q \in [p+1]$. Finally, we set $G_{i,j} := G(\langle f_{i,j}^0, f_{i,j}^1, \dots, f_{i,j}^{p+1} \rangle)$.

We define the *propagator gadgets* as $H_i := G(\langle 3, 6, \dots, 3(t+1) \rangle)$ and $\tilde{H}_i := G(\langle 3t, 6t, \dots, 3(t+1)t \rangle)$; see Figs. 6b and 6c. Note that these gadgets have size $3(t+1) + 1$ and $3t(t+1) + 1$, respectively. For each color class V_i , where $i \in [2, k-1]$, we will take i copies of the gadget H_i , and $k-i+1$ copies of \tilde{H}_i ; whereas for $i=1$ (or $i=k$), we take $k-1$ copies of \tilde{H}_i (or H_i , respectively) only. Let \mathcal{H}_i denote the set containing the copies of H_i , and let $\tilde{\mathcal{H}}_i$ denote the copies of \tilde{H}_i . Note that $|\mathcal{H}_i \cup \tilde{\mathcal{H}}_i| = k+1$ when $i \in [2, k-1]$, and $|\mathcal{H}_i \cup \tilde{\mathcal{H}}_i| = k-1$ when $i \in \{1, k\}$.

Finally, for each $i \in [2, k-2]$, we have a special gadget $G_{i,i} := G(\langle \phi(1,1), \phi(2,2), \dots, \phi(t,t) \rangle)$. Intuitively, this gadget is used to ensure the vertex selected in each $H_i \in \mathcal{H}_i$ is the same as in each $\tilde{H}_i \in \tilde{\mathcal{H}}_i$. However, we also consider $G_{i,i}$ an edge encoding gadget, since it is treated as one in the construction.

In order to describe how these gadgets are joined together in G' , as shown in Fig. 7, we require some terminology. Given some $G_{i,j}$ and $G_{i',j'}$ with $i, j, j' \in [k]$, we say we *connect* $G_{i,j}$ to $G_{i',j'}$ using \tilde{H}_i to describe adding all nine edges between $D(G_{i,j})$ and $B(\tilde{H}_i)$, and all nine edges between $D(\tilde{H}_i)$ and $B(G_{i',j'})$. In this case, we also say \tilde{H}_i *connects from* $G_{i,j}$ and *connects to* $G_{i',j'}$. Given some $G_{i,j}$ and $G_{i',j}$ with $i, i', j \in [k]$, the operation of *connecting* $G_{i,j}$ to $G_{i',j}$ using H_j is defined analogously. We give the following cyclic ordering to the edge encoding gadgets: $(G_{1,2}, G_{1,3}, \dots, G_{1,k}, G_{2,2}, G_{2,3}, \dots, G_{2,k}, \dots, G_{k-1,k-1}, G_{k-1,k})$. For each $G_{i,j}$, we connect this gadget to the next gadget $G_{i',j'}$ in the cyclic ordering that matches on the first index using one of the copies of \tilde{H}_i , and also connect it to the next gadget $G_{i',j}$ in the ordering that matches on the second index using one of the copies of H_j . For example, we connect $G_{1,3}$ to $G_{1,4}$ using a copy of \tilde{H}_1 , and connect $G_{1,3}$ to $G_{2,3}$ using a copy of H_3 . This completes the construction.

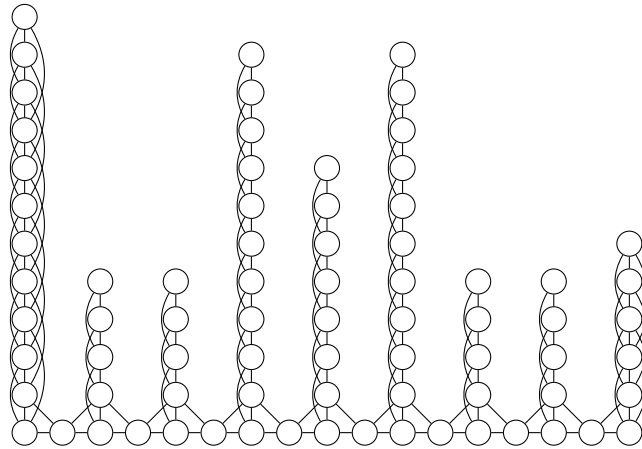

(a) The edge encoding gadget $G_{i,j}$ (with $t = 5$) for the edges $\{v_i^1 v_j^4, v_i^2 v_j^1, v_i^2 v_j^3, v_i^3 v_j^2, v_i^3 v_j^5, v_i^4 v_j^4, v_i^5 v_j^1, v_i^5 v_j^3\}$, encoded as $\langle 12, 18, 24, 36, 45, 57, 63, 69 \rangle$.

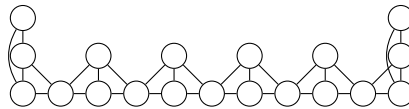

(b) A propagator gadget H_j (with $t = 5$), which will be linked to edge encoding gadgets $G_{i,j}$ with $i \leq j$.

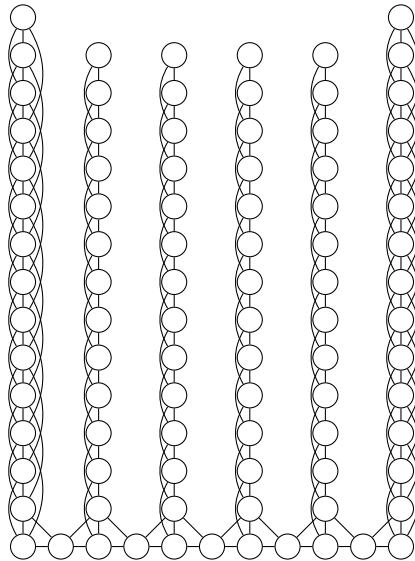

(c) A propagator gadget \tilde{H}_i (with $t = 5$), which will be linked to edge encoding gadgets $G_{i,j}$ with $i \leq j$.

■ **Figure 6** The different uses of the gadgets: the edge encoding gadget and the two kinds of propagator gadgets.

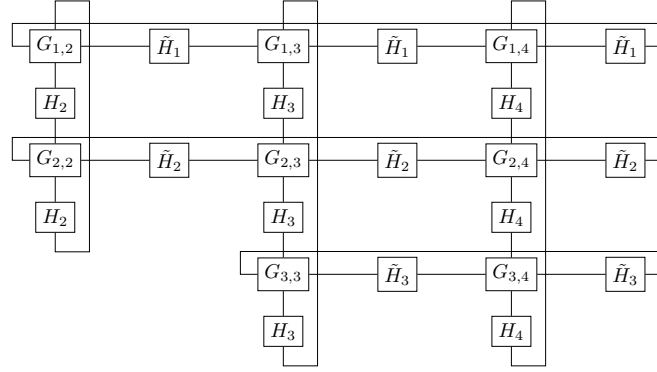

■ **Figure 7** The overall picture with $k = 4$.

Proof of Theorem 24. Observe that each vertex $v \in V(G')$ is contained in precisely one gadget, and so each vertex of G' inherits either a ‘ u ’ label or a ‘ w ’ label from its gadget. In what follows, whenever we refer to an edge encoding gadget $G_{i,j}$, or a propagator gadget \tilde{H}_i or H_j , it is for some $i \in [1, k-1]$ and $j \in [2, k]$ with $i \leq j$.

Treewidth. We now describe a path decomposition of G' that illustrates that its pathwidth, and hence treewidth, is at most $54k - 69$.

First, observe that for a gadget $H := G(\langle x_0, x_1, \dots, x_{z+1} \rangle)$, there is a path decomposition where each bag has size at most 4. By adding $B(H) \cup D(H)$ to every bag, we obtain a path decomposition where each bag has size at most 10; we denote this path decomposition by $\mathcal{P}(H)$. Note that H is only linked to other gadgets in G' by edges with one end in either $B(H)$ or $D(H)$.

Recall that the edge encoding gadgets are joined together using propagator gadgets with respect to the cyclic ordering

$$(G_{1,2}, G_{1,3}, \dots, G_{1,k}, G_{2,2}, G_{2,3}, \dots, G_{2,k}, \dots, G_{k-1,k-1}, G_{k-1,k}).$$

Consider an auxiliary multigraph F on the vertex set $\{G_{i,j} : i \in [1, k-1], j \in [2, k], i \leq j\}$ where there is an edge between $G_{i,j}, G_{i',j'} \in V(F)$ whenever the gadget $G_{i,j}$ is connected to $G_{i',j'}$ using some propagator gadget in G' . (Formally, there is an edge for $i = i'$ and $|j - j'| \in \{1, k - i, k - 2\}$, or $j = j'$ and $|i - i'| \in \{1, j - 1, k - 2\}$.)

We now show that F has pathwidth at most $3k - 5$. Let $\mathcal{G}_1 = \{G_{1,j} : j \in [2, k]\}$ and, for $i \in [2, k-1]$, let $\mathcal{G}_i = \{G_{i,j} : j \in [i, k]\}$. Then $(\mathcal{G}_1 \cup \mathcal{G}_2 \cup \mathcal{G}_3, \mathcal{G}_1 \cup \mathcal{G}_3 \cup \mathcal{G}_4, \dots, \mathcal{G}_1 \cup \mathcal{G}_{k-2} \cup \mathcal{G}_{k-1})$ is a path decomposition for F where the largest bag, the first one, has size $3k - 4$. We denote this path decomposition $\mathcal{P}(F)$.

We extend this to a path decomposition of G' by replacing each bag of $\mathcal{P}(F)$ with a path, which is in turn constructed from several concatenated “subpaths”, one for each gadget. Suppose, for some $i, j \in [k]$ with $i \leq j$, we have that \tilde{H}_i and H_j connect to $G_{i,j}$ in G' , and \tilde{H}'_i and H'_j connect from $G_{i,j}$ in G' ; then we denote $X_{i,j} = D(\tilde{H}_i) \cup D(H_j) \cup B(G_{i,j}) \cup D(G_{i,j}) \cup B(\tilde{H}'_i) \cup B(H'_j)$. Let $Z \subseteq [k] \times [k]$ such that $\bigcup_{(i,j) \in Z} G_{i,j}$ is a bag of the path decomposition of F . From this bag, we construct a path where each bag contains $Q = \bigcup_{(i,j) \in Z} X_{i,j}$. The subpaths of this path are as follows. For each $(i, j) \in Z$ we have a subpath obtained from $\mathcal{P}(G_{i,j})$ by adding Q to each bag. Every edge of F is contained in some bag of the path decomposition, and corresponds to a propagator gadget H of G' . For each such H , we have a subpath obtained from $\mathcal{P}(H)$ by adding Q to each bag. These subpaths are then concatenated together, end to end, to create the path that replaces the

bag $\bigcup_{(i,j) \in Z} G_{i,j}$ in $\mathcal{P}(F)$. After doing this for each bag, we obtain a path decomposition of G' .

Note that $|Z| \leq 3k - 4$, and $|X_{i,j}| = 18$, for any $(i,j) \in Z$. So $|Q| \leq 18(3k - 4)$. A path decomposition $\mathcal{P}(H)$, for some gadget H , has bags with size at most 10, but each bag meets Q in precisely the elements $B(H) \cup D(H)$. So the pathwidth of G' is at most $18(3k - 4) + 4 - 1 = 54k - 69$.

Correctness (\Rightarrow). First, let X be a multicolored k -clique in G ; we will show that G' has a set $S \subseteq V(G')$ such that $|S| = 3\binom{k+1}{2} - 6$ and each component of $G' - S$ has at most d vertices, where $d = 3t^2 + 3t + 3$. Let $\gamma(i)$ be the index of the unique vertex in $X \cap V_i$ for each $i \in [k]$; that is, $X \cap V_i = \{v_i^{\gamma(i)}\}$. For each $H \in \mathcal{H}_i \cup \tilde{\mathcal{H}}_i$, we add the vertex $u_{\gamma(i)}(H)$ to S ; there are $(k-2)(k+1) + 2(k-1) = k(k+1) - 4$ such gadgets, so this many vertices are added to S so far. For each pair $i, j \in k$ with $i < j$, there is some $q \in [p]$ such that $\phi(\gamma(i), \gamma(j)) = f_{i,j}^q$; we add the vertex $u_q(G_{i,j})$ to S . For $i \in [2, k-2]$, we also add the vertex $u_{\gamma(i)}(G_{i,i})$ to S . Now $|S| = k(k+1) - 4 + \binom{k}{2} + k - 2 = 3\binom{k+1}{2} - 6$.

We now consider the size of the components of $G' - S$. We first analyze the size of the components of a gadget $G_{i,j}$, \tilde{H}_i or H_j after deleting S . Note that S meets the vertex set of one of these gadgets in precisely one vertex, and the deletion of this vertex splits the gadget into two components. The two components of $G_{i,j} - u_q$ have $f_{i,j}^q = 3t(\gamma(i) - 1) + 3\gamma(j)$ and $f_{i,j}^{q+1} - f_{i,j}^q = 3t^2 + 3 - (3t(\gamma(i) - 1) + 3\gamma(j))$ vertices. The two components of $\tilde{H}_i - u_{\gamma(i)}$ have $3t\gamma(i)$ and $3t(t+1 - \gamma(i))$ vertices, while the two components of $H_j - u_{\gamma(j)}$ have $3\gamma(j)$ and $3(t+1 - \gamma(j))$ vertices. These gadgets are joined in such a way that the size of a component of $G' - S$ is

$$\begin{aligned} & [3t(\gamma(i) - 1) + 3\gamma(j)] + 3t(t+1 - \gamma(i)) + 3(t+1 - \gamma(j)) \\ &= 3t^2 + 3t + 3 \\ &= [3t^2 + 3 - (3t(\gamma(i) - 1) + 3\gamma(j))] + 3t\gamma(i) + 3\gamma(j), \end{aligned}$$

as required.

(\Leftarrow). Suppose G' has a set $S \subseteq V(G')$ with $|S| \leq 3\binom{k+1}{2} - 6$ such that each component of $G' - S$ has at most d vertices, where $d = 3t^2 + 3t + 3$. We call any such set S a *solution*.

First, we show, loosely speaking, that we may assume each vertex in S is a ‘ u ’ vertex of its gadget, not a ‘ w ’ vertex. Let H be a gadget of G' of order s . There are two cases to consider: the first is when, for some $r \in [1, s-1]$, we have that $S \cap V(P_r(H)) \neq \emptyset$. Suppose $P_r(H)$ contains a pair of adjacent vertices w and w' such that $\{w, w'\} \cap S \neq \emptyset$. If $w \in S$ and $w' \notin S$, then, in $G' - (S \setminus \{w\})$, only the component containing w' can have size more than d , and $|V(P_r(H))| \leq 3t^2 < d$, so replacing w' in S with $u_{r-1}(H)$ or $u_r(H)$ also gives a solution. If $\{w, w'\} \subseteq S$, then $(S \setminus \{w, w'\}) \cup \{u_{r-1}(H), u_r(H)\}$ is also a solution. So we may assume that $V(P_r(H)) \cap S = \emptyset$ for each $r \in [1, s-1]$.

Now we consider the second case; let $G_{i,j}$ be an edge encoding gadget, let $H \in \mathcal{H}_i$ and $\tilde{H} \in \tilde{\mathcal{H}}_j$ connect from $G_{i,j}$, and let J be the set of vertices $V(P_y(G_{i,j})) \cup V(P_z(H)) \cup V(P_z(\tilde{H}))$, for $(y, z) \in \{(p, 0), (0, k+1)\}$. Observe that $G'[J]$ is connected and $|J| \leq d$; intuitively, these are the vertices involved in the “join” of multiple gadgets in G' . We show that if $J \cap S \neq \emptyset$, then there is some solution S' with $J \cap S' = \emptyset$. Let $U := N_{G'}(J)$, so $|U| = 3$. If $|J \cap S| \geq 3$, then $(S \setminus J) \cup U$ is a solution. Moreover, if $|U \setminus S| \leq |J \cap S|$, then $(S \setminus J) \cup U$ is again a solution. Assuming otherwise, we can pick $U' \subseteq U \setminus S$ such that $|U'| = |J \cap S|$. If $G'[(J \cup U) \setminus S]$ is connected, then $S' = (S \setminus J) \cup U'$ is a solution. But since $|J \cap S| \leq 2$, it follows, by the construction of G' , that $G'[J \setminus S]$ is connected. Thus, in the exceptional case, the deletion of $J \cap S$ disconnects some $u \in U \setminus S$ from $G'[J \setminus S]$.

But in this case, if we ensure that U' is chosen to contain u , then we still obtain a solution $S' = (S \setminus J) \cup U'$.

Next, we claim that each edge encoding gadget $G_{i,j}$ or propagator gadget $\tilde{H}_i \in \tilde{\mathcal{H}}_i$, has at least one vertex in S . Consider the subgraph $D_{i,j}$ of G' induced by $V(G_{i,j}) \cup V(\tilde{H}_i) \cup V(H_j)$, where \tilde{H}_i and H_j connect from $G_{i,j}$. Recall that $G_{i,j}$ consists of $3t^2 + 3 + 1$ vertices, \tilde{H}_i consists of $3t^2 + 3t + 1$ vertices, H_j consists of $3t + 3 + 1$ vertices, and hence $D_{i,j}$ has size $2d + 3$. If $V(\tilde{H}_i) \cap S$ is empty, then the connected subgraph of $D_{i,j} - S$ containing $V(\tilde{H}_i)$ also contains $P_p(G_{i,j})$, which has size at least 3, so this connected subgraph contains at least $3t^2 + 3t + 1 + 3 = d + 1$ vertices; a contradiction. Similarly, if $V(G_{i,j}) \cap S$ is empty, then the connected subgraph of $D_{i,j} - S$ containing $V(G_{i,j})$ also contains at least $3t$ vertices of $V(\tilde{H}_i)$, so at least $d + 1$ in total; a contradiction. So $|V(\tilde{H}_i) \cap S|, |V(G_{i,j}) \cap S| \geq 1$, as claimed.

Now we claim that each connected component of $G' - S$ has size exactly d . Pick $S' \subseteq S$ such that $|V(G_{i,j}) \cap S'| = 1$ for each edge encoding gadget $G_{i,j}$, and $|V(\tilde{H}_i) \cap S'| = 1$ for each $\tilde{H}_i \in \tilde{\mathcal{H}}_i$. So $|S'| = 2 \binom{k+1}{2} - 2$, and $|S \setminus S'| = \binom{k+1}{2} - 2$. The graph $G' - S'$ has $\binom{k+1}{2} - 2$ components, and the deletion of each vertex in $S \setminus S'$ further increases the number of components by one. Since $|V(G')| = (2d+3) \binom{k+1}{2} - 2$, each of the $\binom{k+1}{2} - 2$ components of $G' - S'$ has size at least $2d + 1$, so the remaining $\binom{k+1}{2} - 2$ vertices in $S \setminus S'$ must evenly split each of these components into components of size exactly d , as claimed.

Next we show that each gadget $H_j \in \mathcal{H}_j$ also has at least one vertex in S . Suppose we have some H_j for which $S \cap V(H_j) = \emptyset$. We calculate the size, modula 3, of the connected component C of $G' - S$ that contains H_j . Since the size of $V(C) \cap V(\tilde{H}_i)$ or $V(C) \cap V(G_{i,j})$ is congruent to 0 (mod 3), and $|V(H_j)| \equiv 1 \pmod{3}$, we deduce that $|V(C)| \equiv 1 \pmod{3}$; a contradiction. So $|S \cap V(H_j)| \geq 1$ for every $H_j \in \mathcal{H}_j$ with $j \in [2, k]$. Since $|S| = 3 \binom{k}{2}$, it follows that each gadget meets S in precisely one vertex.

Finally, suppose $u_q(G_{i,j}) \in S$, for some $q \in [p]$. Then $\phi(a, b) = f_{i,j}^q$, for some $a, b \in [t]$. Let $\tilde{H}_i \in \tilde{\mathcal{H}}_i$ and $H_j \in \mathcal{H}_j$ be the propagators that connect from $G_{i,j}$. Now, the connected component of $G' - S$ containing $3t^2 + 3 - (3t(a-1) + 3b)$ vertices of $G_{i,j} - u_q$ also contains $3ta'$ vertices of \tilde{H}_i , and $3b'$ vertices of H_j , for some $a', b' \in [t]$. So

$$3t^2 + 3ta' - 3t(a-1) + 3b' - 3b + 3 = 3t^2 + 3t + 3.$$

Working modula t , we deduce that $3(b' - b + 1) \equiv 3 \pmod{t}$, hence $b = b'$. It then follows that $3t(a' - (a-1)) = 3t$, so $a = a'$. Thus $u_a(\tilde{H}_i), u_b(H_j) \in S$.

On the other hand, if, for some $a, b \in [t]$ we have $u_a(\tilde{H}_i), u_b(H_j) \in S$, where \tilde{H}_i and H_j connect to $G_{i,j}$, then the component of $G' - S$ containing vertices from these three gadgets contains $3t(t+1-a)$ vertices from \tilde{H}_i , as well as $3(t+1-b)$ vertices from H_j , and $3t(a'-1) + 3b'$ from $G_{i,j}$ for some $a', b' \in [t]$. Since this component has a total of $3t^2 + 3t + 3$ vertices, working modula t we deduce that $3b' + 3 - 3b \equiv 3 \pmod{t}$, so $b = b'$. It follows that $3t(a - a' + 1) = 3t$, so $a = a'$. Thus, $u_q(G_{i,j}) \in S$ for $q \in [p]$ such that $\phi(a, b) = f_{i,j}^q$.

We deduce that for every $l \in [k]$, there exists some $\gamma(l)$ such that $V(\tilde{H}_l) \cap S = \{u_{\gamma(l)}\}$ for every $\tilde{H}_l \in \tilde{\mathcal{H}}_l$, $V(H_l) \cap S = \{u_{\gamma(l)}\}$ for every $H_l \in \mathcal{H}_l$, and $V(G_{i,j}) \cap S = \{u_q\}$ for $q \in [p]$ such that $f_{i,j}^q = \phi(\gamma(i), \gamma(j))$. It follows that each $v_i^{\gamma(i)} v_j^{\gamma(j)}$ is an edge of G , and $X = \{v_i^{\gamma(i)} : i \in [k]\}$ is a multicolored k -clique in G , as required. \blacktriangleleft

Theorem 24 implies that BOUNDED \mathcal{P} -COMPONENT VERTEX DELETION has no algorithm running in time $f(w)n^{\mathcal{O}(1)}$, assuming $\text{FPT} \neq W[1]$. However, we can say something stronger, assuming the ETH holds. Since, in the parameterized reduction in the previous proof, the treewidth of the reduced instance G' has linear dependence on k , a $f(w)n^{\mathcal{O}(w)}$ -time algorithm for this problem would lead to a $f(k)n^{\mathcal{O}(k)}$ -time algorithm for MULTICOLORED

CLIQUE. But, assuming the ETH holds, no such algorithm for MULTICOLORED CLIQUE exists [12]. So we have the following:

► **Theorem 25.** *Unless the ETH fails, there is no $f(w)n^{o(w)}$ -time algorithm for BOUNDED \mathcal{P} -COMPONENT VERTEX DELETION when \mathcal{P} contains all chordal graphs.*

Furthermore, Marx [14] showed that, assuming the ETH holds, SUBGRAPH ISOMORPHISM has no $f(k)n^{o(k/\log k)}$ -time algorithm, where k is the number of edges in the smaller graph. By reducing from SUBGRAPH ISOMORPHISM, instead of MULTICOLORED CLIQUE, we obtain a lower bound with the combined parameter treewidth and solution size.

► **Theorem 26.** *Unless the ETH fails, there is no $f(k')n^{o(k'/\log k')}$ -time algorithm for BOUNDED \mathcal{P} -COMPONENT VERTEX DELETION, where $k' = w + k$, when \mathcal{P} contains all chordal graphs.*

Proof. Let (G, H) be a SUBGRAPH ISOMORPHISM instance where the task is to find if G has a subgraph isomorphic to H . Let $k := |V(H)|$ and $t := |V(G)|$, and suppose $V(G) = \{v^a : a \in [t]\}$ and $V(H) = \{v_i : i \in [k]\}$. Let $V_i = \{v_i^a : a \in [t]\}$ for each $i \in [k]$, and let G^+ be the graph on the vertex set $\bigcup_{i \in [k]} V_i$ with an edge $v_i^a v_j^b$ if and only if $i \neq j$ and $v^a v^b$ is an edge of G . Now the task is to select $|E(H)|$ edges of G^+ that induce a *multicolored* subgraph of G^+ ; that is, the vertex set of this edge-induced subgraph meets each V_i in exactly one vertex.

We construct G' from G^+ using a similar construction as in the proof of Theorem 24, but we only have an edge encoding gadget $G_{i,j}$ for $1 \leq i < j \leq k$ when $v_i v_j$ is an edge in H . More specifically, we take the subsequence of $(G_{1,2}, G_{1,3}, \dots, G_{1,k}, G_{2,2}, G_{2,3}, \dots, G_{2,k}, \dots, G_{k-1,k-1}, G_{k-1,k})$ consisting of each $G_{i,j}$ for which $v_i v_j \in E(H)$, as well as $G_{i,i}$ for all $i \in [2, k-1]$, and, as before, connect each $G_{i,j}$ to the next $G_{i,j'}$ in the cyclic ordering that matches on the first index using a copy of \tilde{H}_i , and also connect it to the next gadget $G_{i',j}$ in the ordering that matches on the second index using a copy of H_j . Note that $p = |E_{i,j}| = 2|E(G)|$.

By a routine adaptation of Theorem 24, it is easy to see that $\text{tw}(G') = \mathcal{O}(k)$, and that G has a subgraph isomorphic to H if and only if G' has a set $S \subseteq V(G')$ of size at most k' such that each connected component of $G' - S$ has size at most d . Now the parameter in the reduced instance is $k'' := \text{tw}(G') + k' = \mathcal{O}(|V(H)|) + \mathcal{O}(|V(H)|^2) = \mathcal{O}(|E(H)|)$. Thus, an $f(k'')n^{o(k''/\log k'')}$ -time algorithm for BOUNDED \mathcal{P} -COMPONENT VERTEX DELETION would lead to an algorithm for SUBGRAPH ISOMORPHISM running in time $f(|E(H)|)n^{o(|E(H)|/\log |E(H)|)}$. But there is no algorithm for SUBGRAPH ISOMORPHISM with this running time unless the ETH fails [14]. ◀

References

- 1 H. L. Bodlaender, M. Cygan, S. Kratsch, and J. Nederlof. Deterministic single exponential time algorithms for connectivity problems parameterized by treewidth. *Inform. and Comput.*, 243:86–111, 2015.
- 2 H. L. Bodlaender, P. G. Drange, M. S. Dregi, F. V. Fomin, D. Lokshtanov, and M. Pilipczuk. A $c^k n$ 5-Approximation Algorithm for Treewidth. *SIAM J. Comput.*, 45(2):317–378, 2016.
- 3 E. Bonnet, N. Brettell, O. Kwon, and D. Marx. Parameterized vertex deletion problems for hereditary graph classes with a block property. In *Graph-Theoretic Concepts in Computer Science (Proceedings of WG 2016)*, volume 9941 of *Lecture Notes in Comput. Sci.*, pages 233–244, 2016.

- 4 B. Courcelle. The monadic second-order logic of graphs. I. Recognizable sets of finite graphs. *Inform. and Comput.*, 85(1):12–75, 1990.
- 5 M. Cygan, F. V. Fomin, Ł. Kowalik, D. Lokshtanov, D. Marx, M. Pilipczuk, M. Pilipczuk, and S. Saurabh. *Parameterized Algorithms*. Springer, 2015.
- 6 M. Cygan, J. Nederlof, M. Pilipczuk, M. Pilipczuk, J. M. M. van Rooij, and J. O. Wojtaszczyk. Solving connectivity problems parameterized by treewidth in single exponential time (extended abstract). In *2011 IEEE 52nd Annual Symposium on Foundations of Computer Science—FOCS 2011*, pages 150–159. IEEE Computer Soc., Los Alamitos, CA, 2011.
- 7 P. G. Drange, M. S. Dregi, and P. van ’t Hof. On the computational complexity of vertex integrity and component order connectivity. In *Algorithms and computation*, volume 8889 of *Lecture Notes in Comput. Sci.*, pages 285–297. Springer, Cham, 2014.
- 8 J. Enright and K. Meeks. Deleting edges to restrict the size of an epidemic: a new application for treewidth. In *Combinatorial Optimization and Applications*, volume 9486 of *Lecture Notes in Comput. Sci.*, pages 574–585. Springer, 2015.
- 9 M. R. Fellows, F. V. Fomin, D. Lokshtanov, F. Rosamond, S. Saurabh, S. Szeider, and C. Thomassen. On the complexity of some colorful problems parameterized by treewidth. *Information and Computation*, 209(2):143–153, 2011.
- 10 F. V. Fomin, D. Lokshtanov, and S. Saurabh. Efficient computation of representative sets with applications in parameterized and exact algorithms. In *Proceedings of the Twenty-Fifth Annual ACM-SIAM Symposium on Discrete Algorithms*, pages 142–151. ACM, New York, 2014.
- 11 D. Lokshtanov, D. Marx, and S. Saurabh. Known algorithms on graphs on bounded treewidth are probably optimal. In *Proceedings of the Twenty-Second Annual ACM-SIAM Symposium on Discrete Algorithms, SODA 2011, San Francisco, California, USA, January 23-25, 2011*, pages 777–789, 2011.
- 12 D. Lokshtanov, D. Marx, and S. Saurabh. Lower bounds based on the Exponential Time Hypothesis. *Bulletin of the EATCS*, 105:41–72, 2011.
- 13 D. Lokshtanov, D. Marx, and S. Saurabh. Slightly superexponential parameterized problems. In *Proceedings of the Twenty-Second Annual ACM-SIAM Symposium on Discrete Algorithms, SODA 2011, San Francisco, California, USA, January 23-25, 2011*, pages 760–776, 2011.
- 14 D. Marx. Can you beat treewidth? *Theory of Computing*, 6(1):85–112, 2010.